

Damiano Anselmi damiano.anselmi@df.unipi.it

www.df.unipi.it/~anselmi

Matematica e fisica 64 ore = 32 + 32

Prova in itinere di matematica : 28/10/2019 9.00 - 11.30

Prova in itinere di fisica : ultime due ore
aula magna
del corso

Domani non c'è lezione

La recuperiamo giovedì 10/10/2018 dalle 14.30 alle 16.30

Ricevimento : MER 8.30 - 9.30 Piagge

MAR 14.00 - 16.00 = fisica Ed. C

Polo Fibonacci, primo piano, uff. 158

<https://naturali.campusnet.unito.it/didattica/att/a08b.5472.file.pdf>

Lezioni di matematica Console Roggero Romagnoli *

Matematica di base Bugatto Robbiano *

Matematica per le scienze della vita, C&F Sbordone

Matematica. Comprendere e interpretare fenomeni delle
scienze della vita, Villani, Gentili

Insiemi indicati con A, B, C, \dots $x, y, z \dots$

sono collezioni di oggetti, detti elementi dell'insieme
indicati con a, b, c, \dots $x, y, z \dots$

$$A = \{ \underbrace{a, x, y} \} \quad B = \{ c, a \}$$

non importa l'ordine

$a \in A$ "a appartiene ad A"

\emptyset = insieme vuoto = $\{ \}$

$\mathbb{N} = \{ 0, 1, 2, 3, \dots \}$ numeri naturali

$$n, m \in \mathbb{N}$$

$$\{1, 2, 3, \dots\} = \mathbb{N}_+ = \mathbb{N} \setminus \{0\}$$

numeri naturali
positivi

↑ "privato di"

\mathbb{N} è chiuso rispetto al prodotto e alla somma:

il prodotto di due numeri naturali è un
numero naturale

la somma di due numeri naturali è un
numero naturale

non è chiuso per sottrazione o divisione

$$2 - 3 = -1$$

\mathbb{Z} = numeri interi relativi = $\{\dots, -3, -2, -1, 0, 1, 2, \dots\}$

\mathbb{Z} è chiuso sotto somma, prodotto e sottrazione

$$(-3) \cdot (-2) = +6$$

$$+ \cdot + = + \quad - \cdot - = +$$

$$+ \cdot - = -$$

\mathbb{Z} non è chiuso sotto divisione

$$3:2 = \frac{3}{2} \notin \mathbb{Z}$$

non appartiene a

$$-3:2 = -\frac{3}{2} \notin \mathbb{Z}$$

\mathbb{Q} = numeri razionali = $\left\{ \frac{m}{n}, m \in \mathbb{Z}, n \in \mathbb{Z}, n \neq 0 \right\}$

$$\frac{m}{n} = \frac{m \cdot p}{n \cdot p} \quad p \in \mathbb{Z} \quad \frac{3}{2} = \frac{15}{10} = \frac{3 \cdot \cancel{5}}{2 \cdot \cancel{5}}$$

$$q \in \mathbb{Q} \quad q_1 = \frac{m_1}{n_1} \quad q_2 = \frac{m_2}{n_2} \quad \begin{array}{l} \leftarrow \text{numeratore} \\ \leftarrow \text{denominatore} \end{array}$$

$$q_1 \cdot q_2 = \frac{m_1 \cdot m_2}{n_1 \cdot n_2} = \frac{m_1}{n_1} \cdot \frac{m_2}{n_2}$$

$$\frac{2}{7} \cdot \frac{3}{4} = \frac{2 \cdot 3}{7 \cdot 4} = \frac{6}{28} = \frac{3 \cdot \cancel{2}}{14 \cdot \cancel{2}} = \frac{3}{14}$$

$$\begin{aligned} q_1 + q_2 &= \frac{m_1}{n_1} + \frac{m_2}{n_2} = \frac{m_1 \cdot n_2}{n_1 \cdot n_2} + \frac{m_2 \cdot n_1}{n_2 \cdot n_1} = \\ &= \frac{m_1 \cdot n_2 + m_2 \cdot n_1}{n_1 \cdot n_2} \end{aligned}$$

$$\frac{1}{2} + \frac{1}{3} = \frac{1 \cdot 3}{2 \cdot 3} + \frac{1 \cdot 2}{3 \cdot 2} = \frac{3}{6} + \frac{2}{6} = \frac{5}{6}$$

Reciproco: se $q = \frac{m}{n}$ e $q \neq 0$, allora $\frac{1}{q} = \frac{n}{m}$
↖ "diverso da"

il reciproco di $\frac{3}{14}$ è $\frac{14}{3}$

$\mathbb{Q} = \left\{ \begin{array}{l} \text{numeri decimali che hanno un numero} \\ \text{finito di cifre decimali o sono periodici} \end{array} \right\}$

$$0,25 \stackrel{?}{=} \frac{m}{n} = 0,25 \cdot \frac{p}{p} = \left(0,25 \cdot \frac{100}{100} \right) =$$

$$= \frac{25}{100} = \frac{5 \cdot \cancel{5}}{20 \cdot \cancel{5}} = \frac{\cancel{1} \cdot \cancel{5}}{4 \cdot \cancel{5}} = \frac{1}{4}$$

numero decimale periodico: numero decimale tale che le sue cifre decimali contengono una sequenza che si ripete indefinitamente (da un certo punto in poi)

$$\text{Es.: } 0,1216343434\dots = 0,1216\overline{34}$$

$$0,\overline{5} = 0,5555\dots$$

$$10 \cdot 0,\overline{5} = 5,555\dots = 5,0 + 0,555\dots$$

↓
x

$$\begin{array}{r} 10x \\ -x \\ \hline \end{array} = \begin{array}{r} 5 + x \\ -x \\ \hline \end{array}$$

$$9x = 5$$

$$x = \frac{5}{9}$$

$$5 : 9 = 0,55\dots$$

50
50
5 ...

$$0,\overline{5} = \frac{5}{9}$$

\mathbb{R} = insieme dei numeri reali = { tutti i numeri
decimali }

..... ,

0, 12121 1211 12 111 12 1111

 ↑ ↑ ↑ ↑

Tutti i numeri reali che non sono razionali si
chiamano irrazionali.

$$3^2 = 3 \cdot 3 = 9$$

$$5^2 = 25$$

Potenze :

$$x^2 \leftarrow \text{esponente} = x \cdot x$$

$$x^3 = x \cdot x \cdot x$$

$$x^{10} = \underbrace{x \cdot x \cdots x}_{10 \text{ volte}}$$

Radice quadrata

Se $y = x^2$ si dice che x è la radice quadrata di y = quel numero il cui quadrato è y

Si scrive $x = \sqrt{y} = y^{\frac{1}{2}}$

$\sqrt{81} = \pm 9$
 $9 \cdot 9 = 81$
 $(-9) \cdot (-9) = 81$

Radice cubica

Se $y = x^3$, x è detta radice cubica di y

$x = \sqrt[3]{y} = y^{\frac{1}{3}}$

$\sqrt[3]{8} = 2$
 $2 \cdot 2 \cdot 2 = 8$

$$(-2) \cdot (-2) \cdot (-2) = -8$$

$$\sqrt[3]{-8} = -2$$

\mathbb{R} non è chiuso sotto radice quadrata

$$y = x^2 \quad x = \sqrt{y}$$

Se $x > 0$ allora $y = x \cdot x > 0$

x è maggiore di 0
(x positivo)

$$+ \cdot + = +$$

Se $x < 0$ allora $y = x \cdot x > 0$

x è minore di 0
(x negativo)

$$- \cdot - = +$$

Quindi non esiste alcun numero reale tale
che il suo quadrato sia negativo

\nexists numero reale i / $i^2 = -1$ $i = \sqrt{-1}$
non esiste tale che

\exists
esiste

numeri complessi \mathbb{C}

sono fatti di 2 numeri reali

$x + i \cdot y$ dove $i = \sqrt{-1}$ $x \in \mathbb{R}$ parte reale
 $y \in \mathbb{R}$ parte immaginaria

$$(a+b) \cdot c = a \cdot c + b \cdot c \quad \text{distributiva} \quad (*)$$

$$a \cdot (b+c) = a \cdot b + a \cdot c \quad (\otimes x)$$

$$\begin{aligned} (a+b) \cdot (c+d) &= a \cdot (c+d) + b \cdot (c+d) = \\ &= a \cdot c + a \cdot d + b \cdot c + b \cdot d \end{aligned}$$

$$a, b, c, d \in \mathbb{R}$$

$$i \cdot i = -1$$

$$z \in \mathbb{C} \quad z = x + iy \quad \text{dove } x, y \in \mathbb{R}$$

$$w \in \mathbb{C} \quad w = a + ib \quad \text{dove } a, b \in \mathbb{R}$$

$$\begin{aligned} z \cdot w &= (\underline{x+iy}) \cdot (\underline{a+ib}) = x \cdot a + ixb + iya - yb \\ iyib &= i \cdot i \cdot y \cdot b = -y \cdot b \quad \setminus = xa - yb + i(xb + ya) \end{aligned}$$

Si parla di retta reale

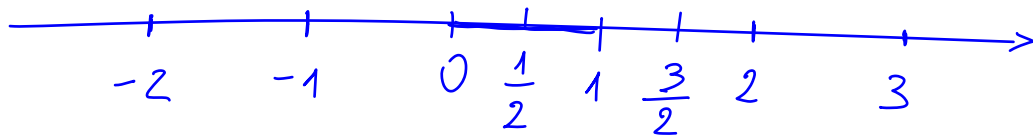

\mathbb{N}
 \mathbb{Z} \mathbb{Q}

è possibile ordinare i numeri reali:

se $a, b \in \mathbb{R}$

- o $a = b$
- o $a < b$
- o $a > b$

Si parla di piano complesso

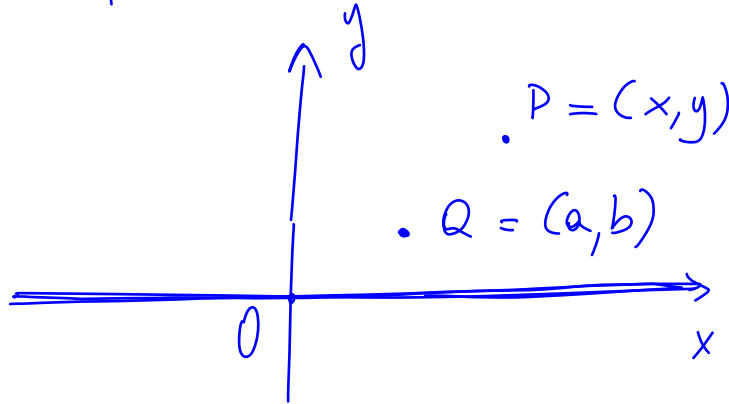

$$x + iy \in \mathbb{C}$$



P
 Q

Non esiste un ordinamento per i numeri complessi

Dati due insiemi A e B si dice che A è contenuto in B , se

$\forall a \in A$ e anche $a \in B$

↑ "per ogni"

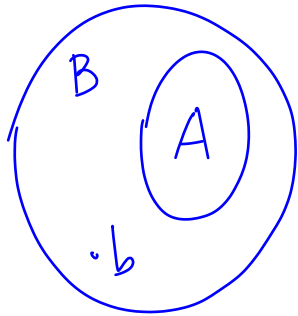

Si scrive:

$A \subset B$ se $\exists b \in B \mid b \notin A$

oppure

$A \subseteq B$ se può essere $A = B$

$\mathbb{N} \subset \mathbb{Z} \subset \mathbb{Q} \subset \mathbb{R} \subset \mathbb{C}$

Altri esempi di insiemi

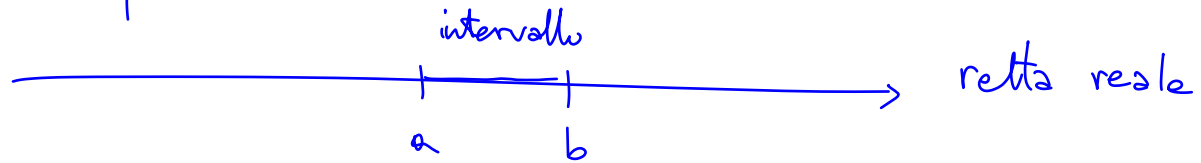

$$[a, b] = \{ x \in \mathbb{R} \mid a \leq x \leq b \}$$

$$(a, b) = \{ x \in \mathbb{R} \mid a < x < b \}$$

$$(a, b] = \{ x \in \mathbb{R} \mid a < x \leq b \}$$

$$[a, b) = \{ x \in \mathbb{R} \mid a \leq x < b \}$$

Unione di insiemi $A \cup B = \{ x \mid x \in A \text{ o } x \in B \}$

Intersezione di insiemi $A \cap B = \{ x \mid x \in A \text{ e } x \in B \}$

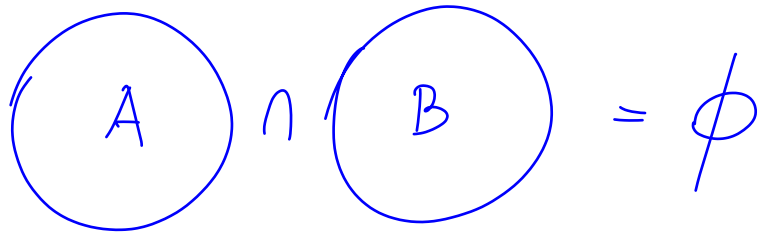
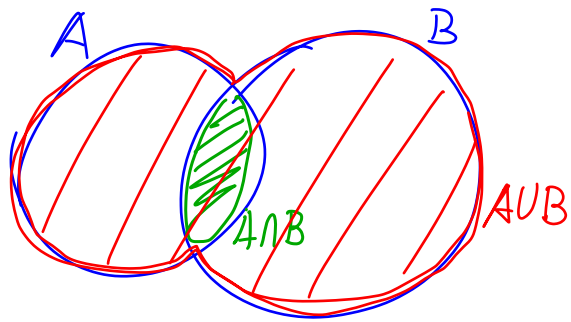

Differenza $A \setminus B = \{x \mid x \in A, x \notin B\}$
 \uparrow privato di B

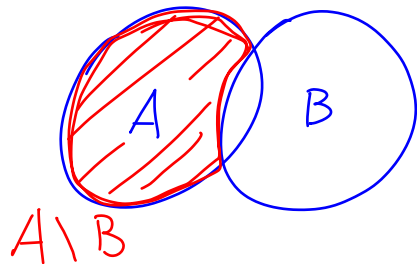

Prodotto cartesiano

$$A \times B = \{ (a, b) \mid a \in A, b \in B \}$$

$$\mathbb{C} = \mathbb{R} \times \mathbb{R}$$

Funzioni fra insiemi

$$f: A \rightarrow B$$

$a \in A$ è mappato
in uno e un
solo elemento di B

è una associazione (relazione,
corrispondenza, mappa) che associa
un elemento di B ad ogni
elemento di A

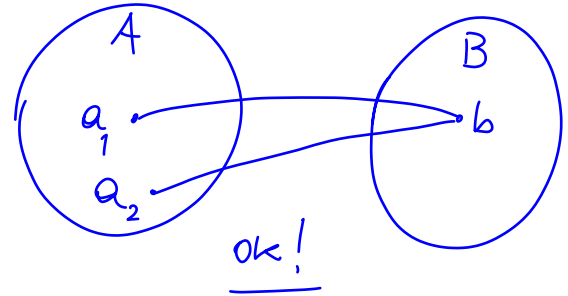
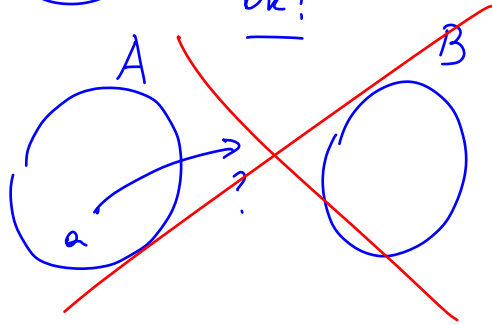
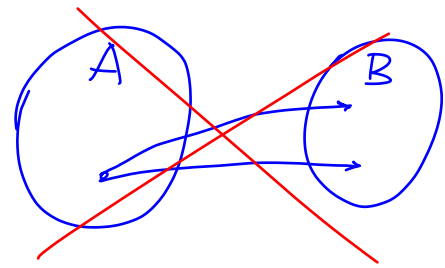
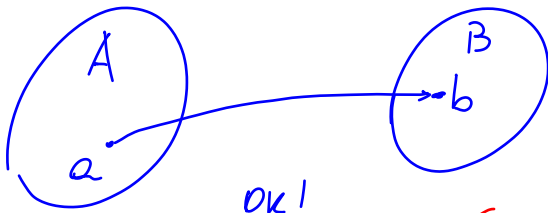

$$f: A \rightarrow B \quad a \mapsto b$$

$$b = f(a) \quad A = \text{dominio della funzione}$$

Esempi: $A = [0, 1]$

$$f: A \rightarrow \mathbb{R} \quad x \in A \quad f(x) = 2$$

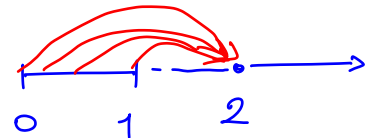

$$f(x) = x$$

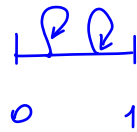

identità

$$f(x) = x + 2$$

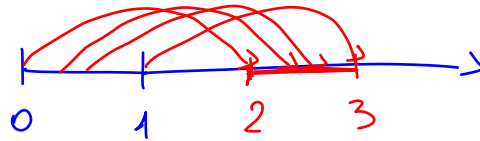

traslazione

$$f(x) = -x$$

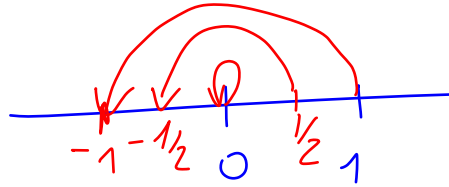

riflessione
rispetto
all'origine

$$f(x) = -x + 2$$

$$f(x) = x^2$$

$$f(x) = \sqrt{x}$$

$$y = f(x)$$

$$x \in A$$

$$y \in B$$

Una funzione si dice iniettiva se elementi distinti di A sono mappati in elementi distinti di B

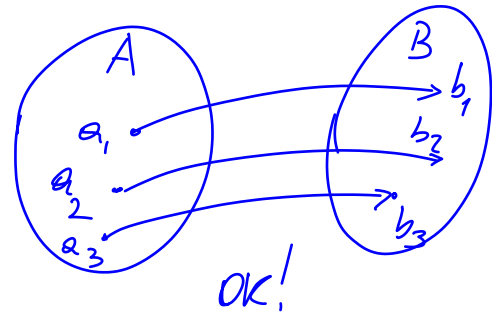
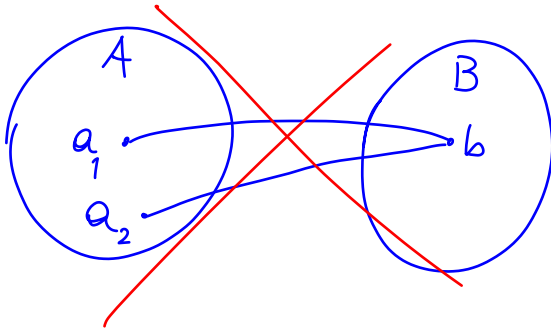

$b = f(a)$ b si dice "immagine" di a

$$\text{Codominio} = \{ b \in B \mid \exists a \in A \mid b = f(a) \}$$

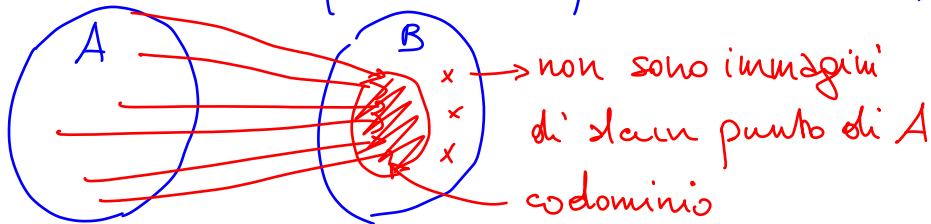

Una funzione è suriettiva se $B = \text{immagine di } A$
 $= \text{codominio di } A$

Es. $f(x) = -x$

$A = [0, 1]$

$B = [-1, 0]$

$f: A \rightarrow B$

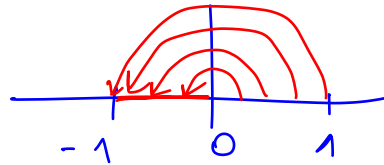

è suriettiva e iniettiva

Se la vedo come $f: [0, 1] \rightarrow \mathbb{R}$
allora non è suriettiva

Una funzione iniettiva e suriettiva si dice biunivoca
ed è invertibile, perché ad ogni elemento
di A corrisponde uno e un solo elemento di B e

e viceversa

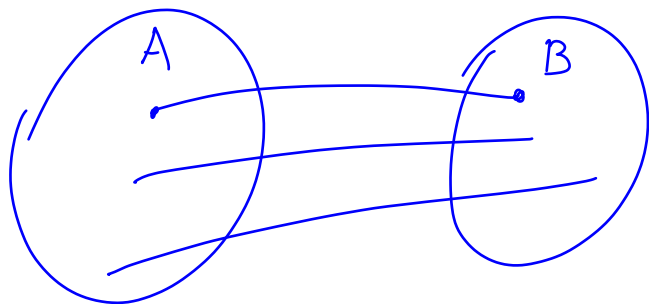

Suriettività : $\forall b \in B \exists a \in A \mid b = f(a)$

iniettività : questo a è unico

$f^{-1} : B \rightarrow A \quad a = f^{-1}(b) \quad \underline{\text{se}}$

inversa della
funzione f

$b = f(a)$

Esempio $f: [0, 1] \rightarrow [2, 3]$

$$f(x) = x + 2$$

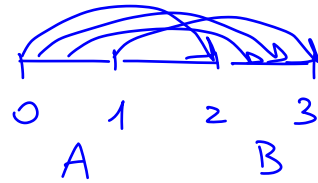

$$y = f(x) = x + 2$$

$$x = f^{-1}(y) = ?$$

$$x = y - 2 = f^{-1}(y)$$

$$y = x + 2$$

$$y - 2 = x + \cancel{2} - \cancel{2} = x$$

||

$$y = x^2$$
$$y = f(x)$$

$$A = [0, 1] = B$$

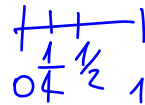

$$x = \sqrt{y} = f^{-1}(y) : [0, 1] \rightarrow [0, 1]$$

Operazioni

$$A = \mathbb{R}$$

Somma : $+$: $A \times A \rightarrow A$

che soddisfa le seguenti proprietà

proprietà associativa

$$\begin{aligned} a + (b + c) &= \\ &= (a + b) + c \end{aligned}$$

$$2 + (3 + 7) = 2 + 10 = 12$$

||

$$(2 + 3) + 7 = 5 + 7 = 12$$

proprietà commutativa:

$$a + b = b + a$$

esistenza dell'elemento neutro (0)

$$a + 0 = a \quad \forall a$$

esistenza dell'opposto: $\forall a \exists b (= -a)$

$$| \quad a + b = 0$$

Prodotto : $A \times A \rightarrow A$

associativa : $a(bc) = (ab)c$

commutativa : $ab = ba$

\exists elemento neutro (1) | $a \cdot 1 = a \quad \forall a$

esistenza del reciproco $b \left(= \frac{1}{a} = a^{-1} \right) \forall a \neq 0 :$

$$a \cdot b = 1$$

$$a^{-2} = \frac{1}{a^2} \quad a^{-n} = \frac{1}{a^n}$$

$$a^2 = \frac{1}{a^{-2}}$$

Es: $a = 3$

$a = -7$

$b = \frac{1}{3}$

$b = -\frac{1}{7}$

distributiva $a \cdot (b+c) = a \cdot b + a \cdot c$

$+ \cdot + = +$

$+ \cdot - = -$

$- \cdot - = - \overset{?}{-}$

$a \cdot (b+c) = a \cdot b + a \cdot c$

$a = -1$
 $b = 1$
 $c = -1$

$0 = (-1) \cdot (1 - 1) = (-1) \cdot 1 + (-1) \cdot (-1) = -1 - 1 = -2$

Successioni

Una successione è una funzione

$$f: \mathbb{N} \rightarrow \mathbb{R}$$

$$0, 1, 2, 3, \dots \rightarrow f(0), f(1), f(2), \dots$$

$$a_0 \quad a_1 \quad a_2 \quad \dots \quad a_n$$

↑ indice

Es.: $a_n = 3n + 2$ successione aritmetica

$$a_0 = 2 \quad a_1 = 5 \quad a_2 = 8 \quad a_3 = 11$$

$$a_n = 2^n = \underbrace{2 \cdot 2 \cdot 2 \cdots 2}_{n \text{ volte}}$$

$$2^0 = 1$$

successione
geometrica

$$a_0 = 1 \quad a_1 = 2 \quad a_2 = 4 \quad a_3 = 8$$

Una successione a_n si dice aritmetica se

$a_{n+1} - a_n$ non dipende da n

$$a_{n+1} - a_n = d \qquad a_{n+1} - \cancel{a_n} + \cancel{a_n} = d + a_n$$

$$\left[\begin{array}{l} a_n = 3n + 2 \\ a_{n+1} - a_n = \underbrace{3 \cdot (n+1) + 2}_{a_{n+1}} - (3n + 2) = \\ = \cancel{3n} + 3 + \cancel{2} - \cancel{3n} - \cancel{2} = 3 \end{array} \right]$$

$a_{n+1} = a_n + d$ relazione di ricorrenza

a_0 è quello che è

$$a_1 = a_0 + d \qquad a_2 = a_1 + d = a_0 + d + d = a_0 + 2d$$

$$a_3 = a_2 + d = a_0 + 2d + d = a_0 + 3d$$

$$a_n = a_0 + nd$$

$$\left[a_n = 3n + 2 \quad d = 3 \quad a_0 = 2 \right]$$

Una successione a_n si dice geometrica se

$\frac{a_{n+1}}{a_n}$ non dipende da n

$$\frac{a_{n+1}}{a_n} = q \quad \text{multiplico} \cdot a_n$$

$$\frac{a_{n+1}}{\cancel{a_n}} \cdot \cancel{a_n} = q \cdot a_n \quad a_{n+1} = q \cdot a_n$$

a_0 è quello che è

$$a_{n+1} = q \cdot a_n$$

$$n=0 \quad a_1 = q \cdot a_0$$

$$n=1 \quad a_2 = q \cdot a_1 = q \cdot q \cdot a_0 = q^2 \cdot a_0$$

$$n=2 \quad a_3 = q a_2 = q \cdot q^2 a_0 = q^3 \cdot a_0$$

....

$$a_n = q^n a_0$$

$$\left[a_n = 2^n \quad q = 2 \quad a_0 = 1 \right]$$

Esercizi Interesse semplice, interesse composto

depositate 1000 € in banca
coll'interesse del 5% annuo

Quanto guadagno dopo 10 anni nei 2 casi
seguenti :

1) preleva il guadagno ogni anno

2) non lo preleva

$$5\% = \frac{5}{100} = 0,05$$

5% di 1000€ vuol dir

$$1000 \cdot \frac{5}{100} \text{ €} = 50 \text{ €}$$

1) g_n = guadagno realizzato dopo n anni

$$g_0 = 0 \quad g_1 = 50 \text{ €}$$

$$g_2 = 2 \cdot 50 \text{ €} = 100 \text{ €}$$

$$g_3 = 3 \cdot 50 \text{ €} \quad \dots \quad g_n = n \cdot 50 \text{ €}$$

$$g_{10} = 10 \cdot 50 \text{ €} = 500 \text{ €} \quad \text{capitale} = 1500 \text{ €}$$

2) chiamiamo S_n la somma depositata in banca dopo n anni

$$S_0 = 1000 \text{ €} \quad S_1 = 1050 \text{ €}$$

nel secondo anno il capitale cresce di

$$\frac{5}{100} \textcircled{1050} \text{ €}$$

Se il capitale è S_n dopo n anni,
l'anno successivo cresce di

$$\frac{5}{100} S_n, \text{ quindi}$$

$$\begin{aligned} S_{n+1} &= S_n + \frac{5}{100} S_n = S_n \left(1 + \frac{5}{100} \right) = S_n \left(1 + \frac{1}{20} \right) = \\ &= S_n \left(\frac{20}{20} + \frac{1}{20} \right) = \frac{21}{20} S_n \end{aligned} \quad \textcircled{S_n = 9^n S_0}$$

$$S_n = \left(\frac{21}{20}\right)^n \cdot 1000 \text{ €}$$

$$S_{10} = \left(\frac{21}{20}\right)^{10} \cdot 1000 \text{ €} \underset{\sim}{\approx} \overset{\text{circa}}{1629} \text{ €}$$

Successione di Fibonacci

$$a_0 = 0 \quad a_1 = 1 \quad a_n = a_{n-1} + a_{n-2}$$

$$n=2 \quad a_2 = a_1 + a_0 = 1$$

0, 1, 1, 2, 3, 5, 8, 13, ...

$a_0, a_1, a_2, a_3,$

Fattoriale di un numero intero n

$$n! = 1 \cdot 2 \cdot 3 \cdot 4 \cdot \dots \cdot n = a_n$$

$$1! = 1 \quad 2! = 2 \cdot 1 = 2$$

$$3! = 1 \cdot 2 \cdot 3 = 6 \quad 4! = 1 \cdot 2 \cdot 3 \cdot 4 = 24 \dots$$

$$a_n = n!$$

$$\frac{a_{n+1}}{a_n} = \frac{(n+1)!}{n!} = \frac{\cancel{1} \cdot \cancel{2} \cdot \cancel{3} \cdot \cancel{4} \cdot \dots \cdot \cancel{n} \cdot (n+1)}{\cancel{1} \cdot \cancel{2} \cdot \cancel{3} \cdot \cancel{4} \cdot \dots \cdot \cancel{n}} = n+1$$

$$a_{n+1} = (n+1)a_n$$

Permutazioni

Dato un insieme A di n oggetti distinti,
si dice permutazione un qualunque loro
ordinamento o allineamento

$$\text{Es.: } A = \{ \underbrace{B, R, V} \}$$

permutazioni: BRV BVR
 RBV RVB $6 = 3!$
 VBR VRB

In generale : $X = \{x_1, \dots, x_n\}$

voglio allineare questi n oggetti

1° oggetto : uno qualunque (n possibilità)

2° oggetto : " " ($n-1$ poss.)

3° " : " " ($n-2$ poss.)

...

totale di possibilità $n! = n \cdot (n-1) \cdot (n-2) \dots 1$

Matrici

"tabelle di numeri"

$$\begin{pmatrix} 1 & -3 & \sqrt{3} & -\frac{1}{7} \\ 0 & 10 & \frac{3}{4} & 5 \end{pmatrix}$$

M
2,4 ← 4 colonne
↑ 2 righe

$$A_{m,n} = \begin{pmatrix} a_{11} & a_{12} & a_{13} & \dots & a_{1n} \\ a_{21} & a_{22} & a_{23} & \dots & a_{2n} \\ a_{31} & & & & \vdots \\ \vdots & & & & \\ a_{m1} & a_{m2} & a_{m3} & \dots & a_{mn} \end{pmatrix} =$$

$$= \begin{pmatrix} a_{ij} \end{pmatrix}$$

$$1 \leq i \leq m$$

$$1 \leq j \leq n$$

a_{ij} = elementi
di matrice

Matrici quadrate : $n=m$

$$A_{22} = \begin{pmatrix} a & b \\ c & d \end{pmatrix}$$

Le matrici con 1 riga o 1 colonna si chiamano vettori

$$A_{21} = \begin{pmatrix} v_1 \\ v_2 \end{pmatrix} \quad A_{12} = (u_1 \ u_2)$$

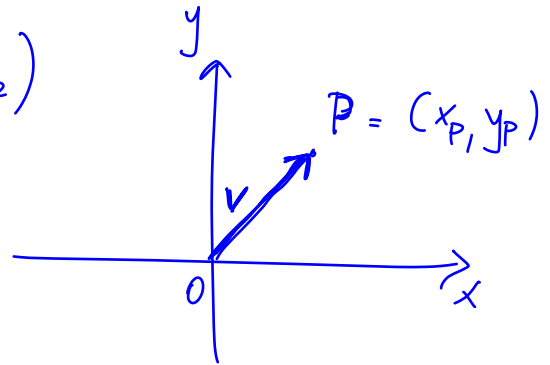

$V = (v_1, \dots, v_n)$ vettore riga

$W = \begin{pmatrix} w_1 \\ \vdots \\ w_n \end{pmatrix}$ vettore colonna

Somma di matrici delle stesse dimensioni

$$A_{mn} + B_{mn} = C_{mn}$$

$$\begin{pmatrix} a_{ij} \end{pmatrix} + \begin{pmatrix} b_{ij} \end{pmatrix} = \begin{pmatrix} c_{ij} \end{pmatrix}$$

$$c_{ij} = a_{ij} + b_{ij}$$

$$A = \begin{pmatrix} 3 & 7 \\ \frac{1}{2} & 2 \end{pmatrix} \quad B = \begin{pmatrix} 8 & 5 \\ 4 & \frac{3}{2} \end{pmatrix}$$

$$C = A + B = \begin{pmatrix} 3+8 & 7+5 \\ \frac{1}{2}+4 & 2+\frac{3}{2} \end{pmatrix} = \begin{pmatrix} 11 & 12 \\ \frac{9}{2} & \frac{7}{2} \end{pmatrix}$$

Proprietà

associativa

$$A + (B + C) = (A + B) + C$$

commutativa

$$A + B = B + A$$

\exists elemento neutro $O = \begin{pmatrix} 0 & 0 & 0 & 0 & \dots & 0 \\ 0 & & & & & \\ 0 & & & & & \\ \vdots & & & \ddots & & \\ 0 & & & & & 0 \end{pmatrix}$

$$A + O = A \quad \forall A$$

\exists l'opposto $B (= -A) \mid A + B = O$

$$A = \begin{pmatrix} a_{ij} \end{pmatrix} \quad B = -A = \begin{pmatrix} -a_{ij} \end{pmatrix}$$

$$A = \begin{pmatrix} 3 & 7 \\ 5 & -2 \end{pmatrix} \quad -A = \begin{pmatrix} -3 & -7 \\ -5 & 2 \end{pmatrix}$$

Moltiplicare una matrice $A = (a_{ij})$ per un numero $\lambda \in \mathbb{R}$

La matrice λA è (λa_{ij})

$$A = \begin{pmatrix} 3 & 7 \\ 5 & -2 \end{pmatrix} \quad \lambda = \frac{1}{2}$$

$$\lambda A = \frac{1}{2} A = \begin{pmatrix} \frac{3}{2} & \frac{7}{2} \\ \frac{5}{2} & -1 \end{pmatrix}$$

Prodotto di matrici

prodotto "righe per colonne"

vettore riga lungo n $V = (v_1, \dots, v_n)$

lo vogliamo moltiplicare per un vettore
colonna lungo n $W = \begin{pmatrix} w_1 \\ \vdots \\ w_n \end{pmatrix}$

$$V \cdot W = (v_1 \dots v_n) \cdot \begin{pmatrix} w_1 \\ \vdots \\ w_n \end{pmatrix} = v_1 \cdot w_1 + v_2 \cdot w_2 + \dots + v_n \cdot w_n$$

$$V = (2 \ 3) \quad W = \begin{pmatrix} \frac{1}{2} \\ 7 \end{pmatrix}$$

$$V \cdot W = (2 \ 3) \cdot \begin{pmatrix} \frac{1}{2} \\ 7 \end{pmatrix} = 2 \cdot \frac{1}{2} + 3 \cdot 7 = 1 + 21 = 22$$

Prodotto di matrici A_{mn} e $B_{nq} = C_{mq}$

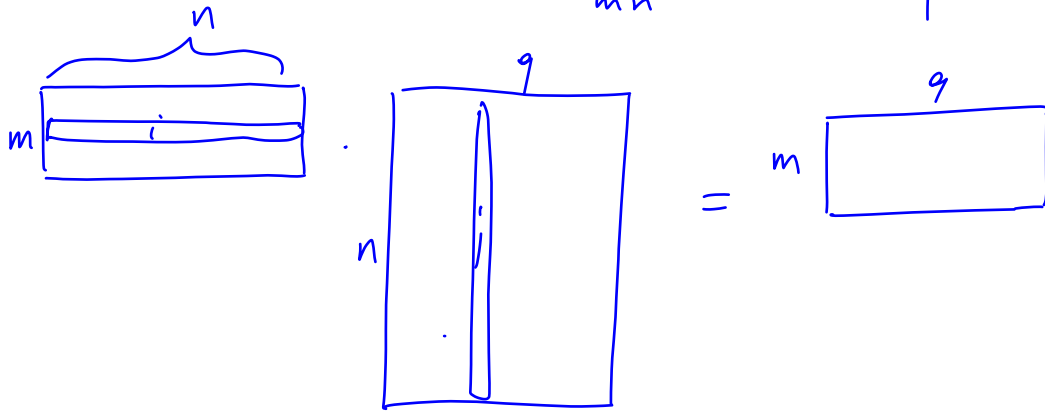

$C_{mq} = (c_{ij} = \text{prodotto tra l}'i\text{-esima riga di } A \text{ e la } j\text{-esima colonna di } B)$

$$A = \begin{pmatrix} \boxed{a_{11} \quad a_{12} \quad \dots \quad a_{1n}} \\ \vdots \\ \boxed{a_{m1} \quad a_{m2} \quad \dots \quad a_{mn}} \end{pmatrix} \quad B_{nq} = \begin{pmatrix} \boxed{b_{n1}} & \boxed{b_{n2}} & \dots & \boxed{b_{nq}} \\ \vdots & \vdots & & \vdots \\ \boxed{b_{m1}} & \boxed{b_{m2}} & \dots & \boxed{b_{mq}} \end{pmatrix}$$

$$C_{mq} = \begin{pmatrix} a_{11}b_{n1} + a_{12}b_{21} + \dots + a_{1n}b_{n1} & a_{11}b_{n2} + a_{12}b_{22} + \dots + a_{1n}b_{2n} \\ \vdots & \vdots \\ a_{m1}b_{n1} + a_{m2}b_{21} + \dots + a_{mn}b_{n1} & a_{m1}b_{n2} + a_{m2}b_{22} + \dots + a_{mn}b_{2n} \end{pmatrix}$$

$$C_{ij} = a_{i1}b_{1j} + a_{i2}b_{2j} + a_{i3}b_{3j} + \dots + a_{in}b_{nj}$$

$$= \sum_{k=1}^n a_{ik}b_{kj}$$

Somma di $a_{ik}b_{kj}$ con k che varia da 1 a n , cioè

$$a_{i1}b_{1j} + a_{i2}b_{2j} + \dots + a_{in}b_{nj}$$

$$A = \begin{pmatrix} 1 & 2 \\ 3 & 4 \end{pmatrix} \quad B = \begin{pmatrix} 3 & 7 \\ 5 & 9 \end{pmatrix}$$

$$C = A \cdot B = \begin{pmatrix} 1 \cdot 3 + 2 \cdot 5 & 1 \cdot 7 + 2 \cdot 9 \\ 3 \cdot 3 + 4 \cdot 5 & 3 \cdot 7 + 4 \cdot 9 \end{pmatrix} = \begin{pmatrix} 13 & 25 \\ 29 & 57 \end{pmatrix}$$

$$A = \begin{pmatrix} a & b \\ c & d \end{pmatrix} \quad B = \begin{pmatrix} e & f \\ g & h \end{pmatrix}$$

$$C = A \cdot B = \begin{pmatrix} ae + bg & af + bh \\ ce + dg & cf + dh \end{pmatrix}$$

Il prodotto tra matrici non è commutativo

$$A \cdot B \neq B \cdot A$$

$$B = \begin{pmatrix} 3 & 7 \\ 5 & 9 \end{pmatrix}$$

$$A = \begin{pmatrix} 1 & 2 \\ 3 & 4 \end{pmatrix}$$

$$B \cdot A = \begin{pmatrix} 24 & 34 \\ 32 & 46 \end{pmatrix}$$

$B \cdot A$ non ha senso se $q \neq m$

$$B_{nq} \cdot A_{mu}$$

Valgono la proprietà associativa

$$(A \cdot B) \cdot C = A \cdot (B \cdot C)$$

e la proprietà distributiva

$$A \cdot (B + C) = A \cdot B + A \cdot C$$

$$(A + B) \cdot C = A \cdot C + B \cdot C$$

\exists l'elemento neutro $\mathbb{1} =$

$$\begin{pmatrix} 1 & 0 & 0 & 0 & 0 \\ 0 & 1 & 0 & 0 & 0 \\ 0 & 0 & 1 & 0 & 0 \\ 0 & 0 & 0 & 1 & 0 \\ 0 & 0 & 0 & 0 & 1 \end{pmatrix}$$

$$\mathbb{1} \cdot A = A \cdot \mathbb{1} = A$$

diagonale

$$A = \begin{pmatrix} a & b \\ c & d \end{pmatrix} \quad B = \begin{pmatrix} e & f \\ g & h \end{pmatrix} \quad \text{Se } B = \mathbb{1} \quad \text{vuol dire}$$

$$e = 1 \quad f = 0 \\ g = 0 \quad h = 1$$

$$C = A \cdot B = \begin{pmatrix} ae + b\cancel{g} & af + b\cancel{h} \\ ce + d\cancel{g} & cf + d\cancel{h} \end{pmatrix} =$$

$$= \begin{pmatrix} a & b \\ c & d \end{pmatrix} = A$$

Esistenza della matrice inversa

Dato A , $\exists B$ | $A \cdot B = \mathbb{1} = B \cdot A$?
 matrice quadrata Non sempre

$A \cdot B = 0 \not\Rightarrow A = 0 \text{ o } B = 0$
non implica
 $a \cdot b = 0$ (numeri)

$$A = \begin{pmatrix} 1 & 1 \\ 1 & 1 \end{pmatrix} \quad B = \begin{pmatrix} 1 & 1 \\ -1 & -1 \end{pmatrix}$$

$$C = A \cdot B = \begin{pmatrix} 1 \cdot 1 + 1 \cdot (-1) & 0 \\ 0 & 0 \end{pmatrix} = 0$$

L'inversa A^{-1} di una matrice $\sqrt{\text{quadrata}} A$ (cioè quella matrice A^{-1} tale che $A^{-1} \cdot A = A \cdot A^{-1} = \mathbb{1}$) esiste

se e solo se $\det A$ (il determinante di A)
non è zero

$$A = \begin{pmatrix} a & b \\ c & d \end{pmatrix}$$

$$\det A = ad - bc$$

$$A^{-1} = \frac{1}{ad-bc} \begin{pmatrix} d & -b \\ -c & a \end{pmatrix} = \lambda B \quad \lambda = \frac{1}{ad-bc}$$
$$B = \begin{pmatrix} d & -b \\ -c & a \end{pmatrix}$$

$$A^{-1} \cdot A = \mathbb{1} = \lambda B \cdot A = \mathbb{1} = \begin{pmatrix} 1 & 0 \\ 0 & 1 \end{pmatrix}$$

$$B \cdot A = \begin{pmatrix} d & -b \\ -c & a \end{pmatrix} \cdot \begin{pmatrix} a & b \\ c & d \end{pmatrix} = \begin{pmatrix} da-bc & 0 \\ 0 & ad-bc \end{pmatrix}$$

Applicazioni: sistemi di equazioni lineari

$$ax = b$$

è un'equazione lineare

$$a \neq 0 \quad x = \frac{b}{a}$$

x = incognita

a, b sono dati

Se $a=0$ e $b \neq 0$

è assurda ($0=b$)

lineare = l'incognita compare
al massimo elevata alla potenza

1 (~~x^2~~ , ~~x^3~~ , ~~x^4~~ ...)

incognite x_1, \dots, x_n

a_1, \dots, a_n, b numeri
dati

un'equazione lineare ha la forma

~~x_1~~ ~~x_2~~ , ~~x_3~~ ~~x_2~~

$$a_1 x_1 + a_2 x_2 + a_3 x_3 + \dots + a_n x_n = b$$

Sistema di m equazioni lineari

$$\left\{ \begin{array}{l} a_{11} x_1 + a_{12} x_2 + a_{13} x_3 + \dots + a_{1n} x_n = v_1 \\ a_{21} x_1 + a_{22} x_2 + \dots + a_{2n} x_n = v_2 \\ \vdots \\ a_{m1} x_1 + a_{m2} x_2 + \dots + a_{mn} x_n = v_m \end{array} \right.$$

$$\boxed{AX = V}$$

$$X = \begin{pmatrix} x_1 \\ \vdots \\ x_n \end{pmatrix}$$

$$A = (a_{ij})$$

$$V = \begin{pmatrix} v_1 \\ \vdots \\ v_m \end{pmatrix}$$

$$A \cdot X = V \quad V = \text{termine noto}$$

Se conoscete A^{-1} avete risolto il sistema:

$$A^{-1} \cdot A \cdot X = A^{-1} \cdot V = X$$

$\underbrace{\hspace{10em}}$

\perp

$$X = A^{-1} \cdot V$$

$$A = \begin{pmatrix} a_{11} & a_{12} & \dots & a_{1n} \\ a_{21} & a_{22} & \dots & a_{2n} \\ \vdots & & & \\ a_{m1} & \dots & & a_{mn} \end{pmatrix} \quad X = \begin{pmatrix} x_1 \\ \vdots \\ x_n \end{pmatrix} \quad V = \begin{pmatrix} v_1 \\ \vdots \\ v_n \end{pmatrix}$$

$$A \cdot X = \begin{pmatrix} a_{11}x_1 + a_{12}x_2 + \dots + a_{1n}x_n \\ a_{21}x_1 + a_{22}x_2 + \dots + a_{2n}x_n \\ \vdots \\ a_{m1}x_1 + \dots + a_{mn}x_n \end{pmatrix} = \begin{pmatrix} v_1 \\ v_2 \\ \vdots \\ v_n \end{pmatrix}$$

$$eq_1 = 0$$

$$eq_2 = 0$$

$$eq_1 = (a_{11}x_1 + a_{12}x_2 + \dots + a_{1n}x_n - v_1)$$

$$eq_2 = (a_{21}x_1 + a_{22}x_2 + \dots + a_{2n}x_n - v_2)$$

$$\lambda \neq 0$$

$$\lambda eq_1 = 0$$

$$\lambda a_{11}x_1 + \lambda a_{12}x_2 + \dots + \lambda a_{1n}x_n - \lambda v_1$$

$$eq_1 = 0$$

\Leftrightarrow

$$\lambda eq_1 = 0$$

se e solo se

$$\begin{cases} eq_1 = 0 \\ eq_2 = 0 \end{cases}$$

\Leftrightarrow

$$\begin{cases} eq_1 = 0 \\ eq_2 + \lambda eq_1 = 0 \end{cases}$$

λ qualunque

Riduzione di una matrice (metodo di Gauss)

Data una matrice A qualunque facciamo le seguenti operazioni:

- i) moltiplichiamo tutti gli elementi di una riga per $\lambda \neq 0$
- ii) scambiamo due righe
- iii) sommiamo (termine a termine) a una riga un'altra riga moltiplicata per $\lambda \neq 0$

Usando questo metodo si può sempre ridurre una matrice alla forma seguente:

$$\begin{pmatrix} a & x & x & x & x & \dots \\ 0 & b & x & x & x & \dots \\ 0 & 0 & c & x & x & \dots \\ 0 & 0 & 0 & d & x & \dots \\ \vdots & \vdots & \vdots & \vdots & \vdots & \ddots \end{pmatrix}$$

tutti zeri sotto la
diagonale

Se la matrice è quadrata e la forma

$$T = \begin{pmatrix} a_{11} & a_{12} & a_{13} & a_{14} \\ 0 & a_{22} & a_{23} & a_{24} \\ 0 & 0 & a_{33} & a_{34} \\ 0 & 0 & 0 & a_{44} \end{pmatrix}$$

si dice matrice
triangolare

$$\det T = a_{11} a_{22} a_{33} a_{44}$$

Il determinante di una matrice triangolare è
il prodotto degli elementi sulla diagonale

e uso le operazioni i) ii) e iii) per ridurla
alla forma

$$\left(\begin{array}{c|c} \mathbb{1}_{nn} & B_{nn} \end{array} \right)$$

allora $B \cdot A = \mathbb{1}$

e $A \cdot B = \mathbb{1}$

cioè $B = A^{-1}$

Esempio

$$A = \begin{pmatrix} a & b \\ c & d \end{pmatrix}$$

Considero $X = \begin{pmatrix} a & b & 1 & 0 \\ c & d & 0 & 1 \end{pmatrix}$

Voglio arrivare a

$$X' = \begin{pmatrix} 1 & 0 & e & f \\ 0 & 1 & g & h \end{pmatrix}$$

Supponiamo che $\det A = ad - bc \neq 0$

allora non è possibile che a e c
siano entrambi 0

Possiamo assumere $a \neq 0$ a meno di scambiare le

righe

$$X = \begin{pmatrix} a & b & 1 & 0 \\ c & d & 0 & 1 \end{pmatrix} \quad a \neq 0$$

i) moltiplichiamo tutti gli elementi della prima
riga per $\frac{1}{a}$

$$X \rightarrow \begin{pmatrix} 1 & \frac{b}{a} & \frac{1}{a} & 0 \\ c & d & 0 & 1 \end{pmatrix}$$

iii) sottraggo alla 2^a riga la 1^a moltiplicata per c

$$1^A \rightarrow 1^A \quad 2^A \rightarrow 2^A - c \cdot 1^A$$

$$\rightarrow \begin{pmatrix} 1 & \frac{b}{a} & \frac{1}{a} & 0 \\ 0 & d - \frac{cb}{a} & -\frac{c}{a} & 1 \end{pmatrix}$$

$$\det A =$$

$$= ad - bc$$

$$\frac{\det A}{a} = d - \frac{bc}{a}$$

proprietà distributiva

$$= \begin{pmatrix} 1 & \frac{b}{a} & \frac{1}{a} & 0 \\ 0 & \frac{\det A}{a} & -\frac{c}{a} & 1 \end{pmatrix}$$

$$\frac{1}{a} (ad - bc)$$

$$= \frac{ad}{a} - \frac{bc}{a}$$

i) divido la 2^a riga per $\frac{\det A}{a}$

(o la moltiplico per $\frac{a}{\det A}$)

$$\begin{pmatrix} 1 & \frac{b}{a} & \frac{1}{a} & 0 \\ 0 & 1 & -\frac{c}{\cancel{a} \det A} & \frac{a}{\det A} \end{pmatrix} \quad \frac{1}{a} - \frac{b}{a} \left(-\frac{c}{\det A} \right) =$$
$$= \frac{1}{a} + \frac{bc}{a \det A}$$

iii) $1^A \rightarrow 1^A - \frac{b}{a} \cdot 2^A \quad 2^A \rightarrow 2^A$

$$\begin{pmatrix} 1 & 0 & \frac{d}{\det A} & -\frac{b}{\det A} \\ 0 & 1 & \frac{-c}{\det A} & \frac{a}{\det A} \end{pmatrix}$$

$$\frac{1}{a} + \frac{bc}{a \det A} = \frac{\det A + bc}{a \det A} =$$

$$= \frac{ad - \cancel{bc} + \cancel{bc}}{a \det A} = \frac{\cancel{d}d}{\cancel{a} \det A} = \frac{d}{\det A}$$

$$A^{-1} = \frac{1}{\det A} \begin{pmatrix} d & -b \\ -c & a \end{pmatrix} \quad : \underline{\text{ok!}}$$

Risolvere un sistema di equazioni lineari

Esercizio

$$\begin{cases} 1x + 2y - 4z = 0 \\ 3x + 0y + 6z = -1 \\ 4x + 4y - 6z = 1 \end{cases}$$

$$V = \begin{pmatrix} 0 \\ -1 \\ 1 \end{pmatrix}$$

$$A = \begin{pmatrix} 1 & 2 & -4 \\ 3 & 0 & 6 \\ 4 & 4 & -6 \end{pmatrix}$$

$$X = \begin{pmatrix} x \\ y \\ z \end{pmatrix}$$

$$AX = V$$

1° modo per risolverlo :

trovare

A^{-1}
(quella matrice
tale che
 $A^{-1} \cdot A = A \cdot A^{-1} = \mathbb{1}$)

$$A X = V$$

Moltiplico per A^{-1}

$$(A^{-1} \cdot A) \cdot X = A^{-1} \cdot V$$

||

$$\mathbb{1} \cdot X = X = A^{-1} \cdot V$$

2° modo :

considero

$$\left(\begin{array}{c|c} A & V \end{array} \right)$$

la manipolo ((i) (ii) e (iii)) fino a

$$\left(\begin{array}{c|c} \mathbb{1} & S \end{array} \right)$$

$$\left(\begin{array}{ccc|c} 1 & 2 & -4 & 0 \\ 3 & 0 & 6 & -1 \\ 4 & 4 & -6 & 1 \end{array} \right)$$

$$2^A \rightarrow 2^A - 3 \cdot 1^A$$

$$3^A \rightarrow 3^A - 4 \cdot 1^A$$

$$\left(\begin{array}{ccc|c} 1 & 2 & -4 & 0 \\ 0 & -6 & 18 & -1 \\ 0 & -4 & 10 & 1 \end{array} \right)$$

$$-6 + (-4) \cdot (-4)$$

$$-4 + x(-6) = 0$$

$$3^A \rightarrow 3^A - \frac{2}{3} \cdot 2^A$$

$$x = -\frac{2}{3}$$

$$-4 \rightarrow -4 + \frac{2}{3} (+\cancel{2}) = -4 + 4 = 0$$

$$\left(\begin{array}{ccc|c} 1 & 2 & -4 & 0 \\ 0 & -6 & 18 & -1 \\ 0 & 0 & -2 & 5/3 \end{array} \right)$$

$$10 - \frac{2}{3} \cdot 18^6 = -2$$

$$1 + \frac{2}{3} \cdot (+1) = \frac{3}{3} + \frac{2}{3} = \frac{5}{3}$$

$$1^A \rightarrow 1^A + \frac{1}{3} \cdot 2^A$$

$$2 \rightarrow 2 + x(-6) = 0$$

$$x = \frac{2}{6} = \frac{1}{3}$$

$$\left(\begin{array}{ccc|c} 1 & 0 & 2 & -\frac{1}{3} \\ 0 & -6 & 18 & -1 \\ 0 & 0 & -2 & 5/3 \end{array} \right)$$

$$-4 + \frac{1}{3} 18^6 = 2$$

$$1^A \rightarrow 1^A + 3^A$$

$$\begin{pmatrix} 1 & 0 & 0 & 4/3 \\ 0 & -6 & 18 & -1 \\ 0 & 0 & -2 & 5/3 \end{pmatrix}$$

$$2^A \rightarrow 2^A + 9 \cdot 3^A \quad 18 + x(-2) = 0 \quad x = 9$$

$$\begin{pmatrix} 1 & 0 & 0 & 4/3 \\ 0 & -6 & 0 & 14 \\ 0 & 0 & -2 & 5/3 \end{pmatrix}$$

$$-1 + 9 \cdot \frac{5}{3} = \frac{42}{3}$$

$$2^A \rightarrow -\frac{1}{6} \cdot 2^A$$

$$3^A \rightarrow -\frac{1}{2} 3^A$$

$$\begin{pmatrix} 1 & 0 & 0 & \frac{4}{3} \\ 0 & 1 & 0 & -\frac{7}{3} \\ 0 & 0 & 1 & -\frac{5}{6} \end{pmatrix}$$

$$x = \frac{4}{3}$$

$$y = -\frac{7}{3}$$

$$z = -\frac{5}{6}$$

$$\begin{cases} 1x + 2y - 4z = 0 \\ 3x + 0y + 6z = -1 \leftarrow \\ 4x + 4y - 6z = 1 \end{cases}$$

$$x + 2y - 4z = \frac{4}{3} + 2\left(-\frac{7}{3}\right) + \cancel{4}\left(\frac{\cancel{+5}}{3}\right) =$$

$$= \frac{4}{3} - \frac{14}{3} + \frac{10}{3} = 0$$

$$3x + 6z = \cancel{3} \cdot \frac{4}{\cancel{3}} + \cancel{6}\left(-\frac{5}{\cancel{6}}\right) = -1$$

Funzioni : $f: D \rightarrow \mathbb{R}$

$D \subset \mathbb{R}$ $D = \text{dominio}$

$y = f(x)$ $x = \text{variabile indipendente}$
 $y = \text{variabile dipendente}$

L'insieme dei punti con coordinate cartesiane

$(x, y) = (x, f(x))$ definisce il grafico della
funzione

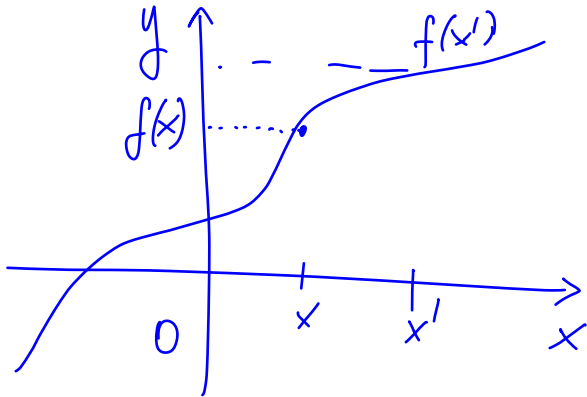

$$y = x$$

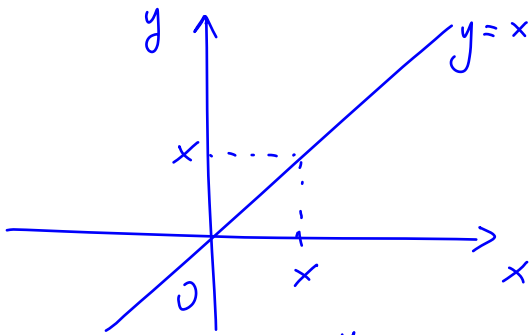

diagonale

$$D = \mathbb{R}$$

$$y = x + 2$$

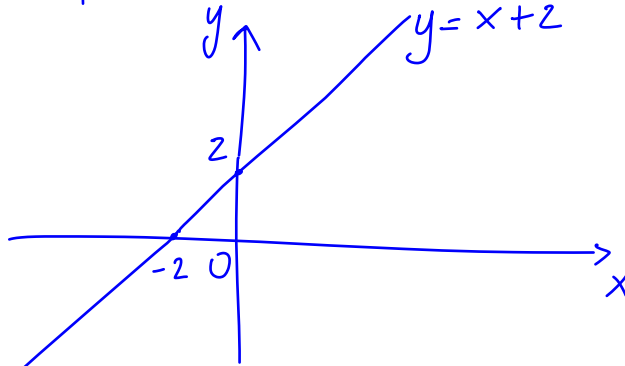

quella di sopra
traslata di 2
verso l'alto

$$D = \mathbb{R}$$

$$y = x^2$$

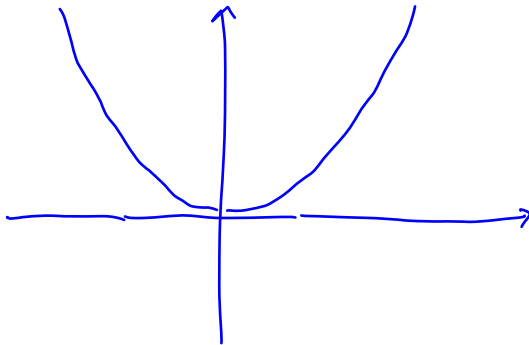

parabola

$$D = \mathbb{R}$$

$$y = \sqrt{x} \quad f: D \rightarrow \mathbb{R}$$

$$D \subset \mathbb{R}$$

$$D = \mathbb{R}_+ = \{x \in \mathbb{R} : x \geq 0\}$$

$$\sqrt{\frac{1}{4}} = \frac{1}{2}$$

$$\frac{1}{4} = \frac{1}{2} \cdot \frac{1}{2}$$

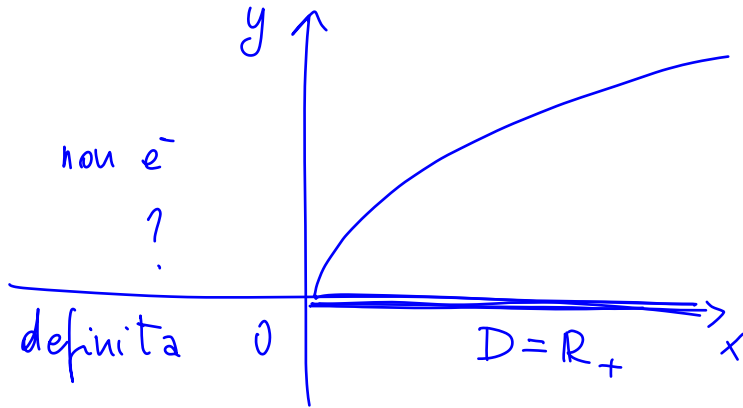

$$f(x) = \sqrt{x-3}$$

$$D = ?$$

$$x-3 \geq 0$$

$$D = [3, \infty)$$

$$x \geq 3$$

" ∞ " = infinito

$$y = \frac{1}{x}$$

$$D = ? \quad x \neq 0$$

$$D = \mathbb{R} \setminus \{0\}$$

↑ "privato di"

$$y = \sqrt{x(x-2)}$$

$$D = ?$$

argomento ≥ 0

chiedo $x(x-2) \geq 0$

$$a \cdot b \geq 0$$

1) ~~$x \geq 0 \quad x \geq 2$~~

• $+$ · $+$ = $+$

$+$ · $-$ = $-$ · $+$ = $-$

2) ~~$x \leq 0 \quad x \leq 2$~~

• $-$ · $-$ = $+$

1) $x \geq 2$

$$D = (-\infty, 0] \cup [2, +\infty)$$

2) $x \leq 0$

$$f(x) = \sqrt{(-x)(x+2)} \quad D = ?$$

$$(-x)(x+2) \geq 0$$

$$1) \quad -x \geq 0 \quad x+2 \geq 0 \quad \Leftrightarrow \quad x \leq 0 \quad x \geq -2 \quad (*)$$

$$2) \quad -x \leq 0 \quad x+2 \leq 0 \quad \Leftrightarrow \quad x \geq 0 \quad x \leq -2$$

impossibile

di segno opposte: se $a \geq b$

allora $-a \leq -b$

Solo la 1) è accettabile $-2 \leq x \leq 0$

$$D = [-2, 0]$$

Continuità

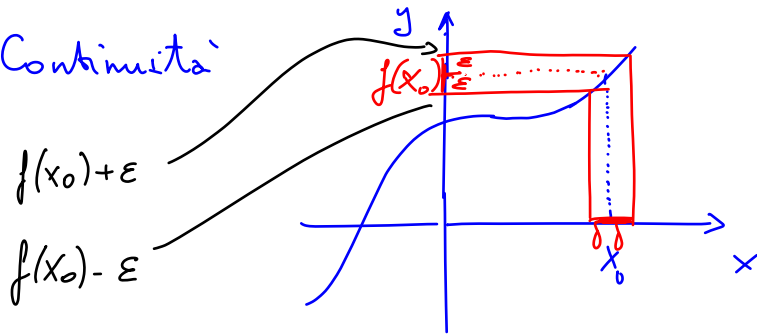

"non ha salti o interruzioni"

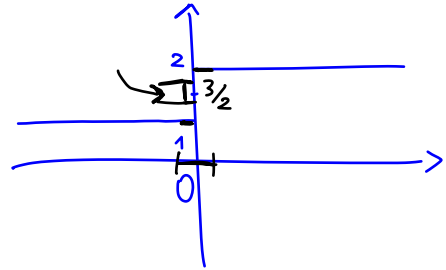

Una funzione $f: D \rightarrow \mathbb{R}$
 si dice continua in $x_0 \in D$
 se

$$f(x) = \begin{cases} 1 & \text{per } x < 0 \\ 2 & \text{per } x > 0 \\ \frac{3}{2} & \text{per } x = 0 \end{cases}$$

$$\forall \varepsilon > 0 \quad \exists \delta > 0 \quad |$$

"arbitrariamente piccolo"

↑
piccolo o no

$$\forall x \in (x_0 - \delta, x_0 + \delta)$$

"intorno di x_0 "

$$- \varepsilon + f(x_0) < f(x) < f(x_0) + \varepsilon$$

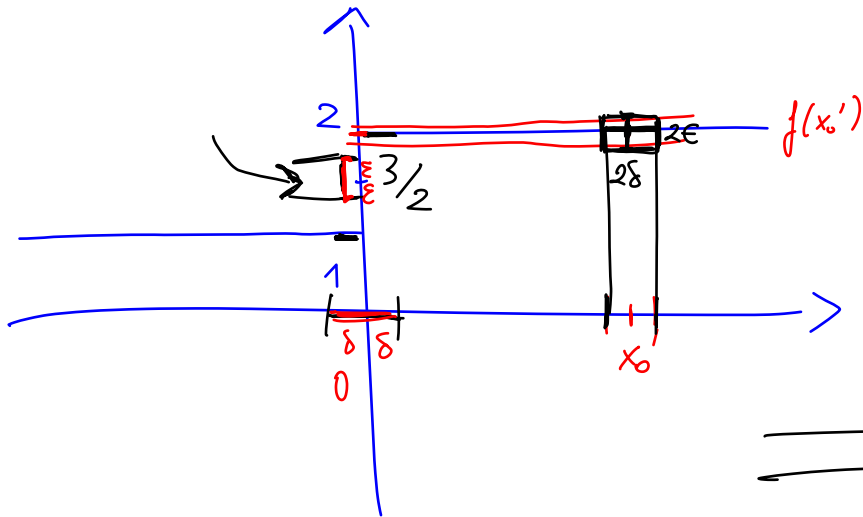

questa funzione
 è discontinua in
 $x_0 = 0$

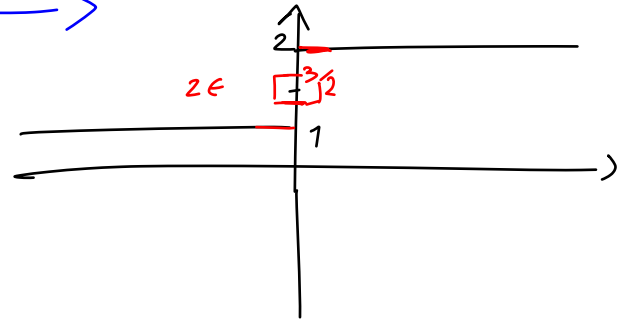

$$f(x) = \begin{cases} 1 & \text{per } x < 0 \\ 2 & \text{per } x > 0 \\ \frac{3}{2} & \text{per } x = 0 \end{cases} \quad x_0 \quad f(x_0) = \frac{3}{2}$$

$$\varepsilon = \frac{1}{1000 \dots}$$

$$f(x_0) - \varepsilon = \frac{3}{2} - \frac{1}{1000 \dots}$$

$$f(x_0) + \varepsilon = \frac{3}{2} + \frac{1}{1000 \dots}$$

~~$\delta > 0$~~ colle
 proprietà
 necessarie

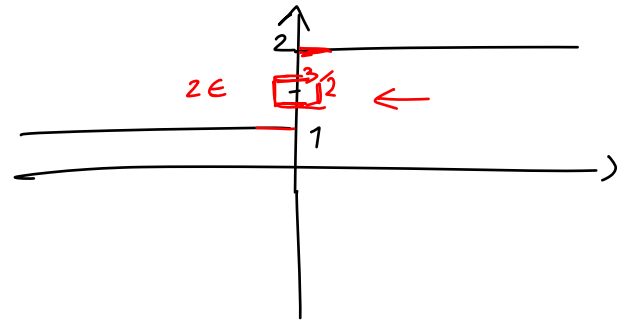
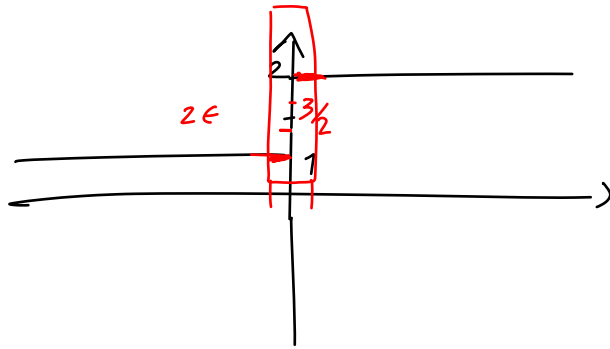

Funzione continua a tratti : è una funzione continua tranne che in un numero finito di punti

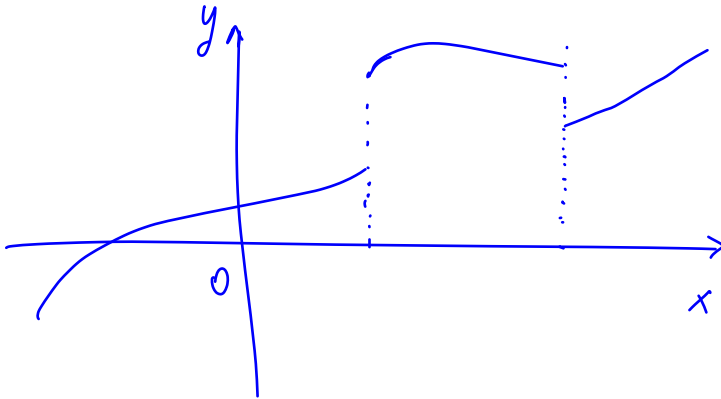

Funzioni crescenti e decrescenti

$f(x)$ è crescente in $[a, b]$ se $\forall x_1, x_2 \in [a, b]$

$$x_1 < x_2 \Rightarrow f(x_1) < f(x_2)$$

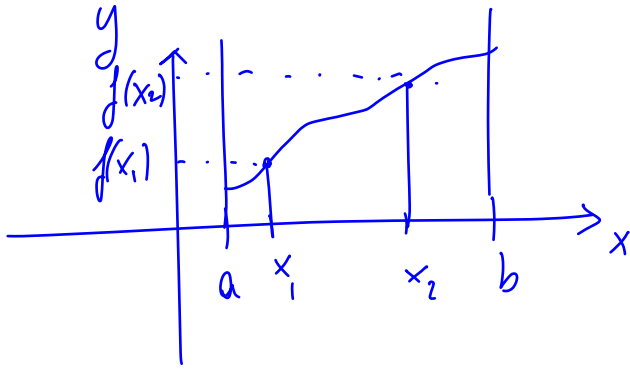

è decrescente se $\forall x_1, x_2 \in [a, b]$

$$x_1 < x_2 \Rightarrow f(x_1) > f(x_2)$$

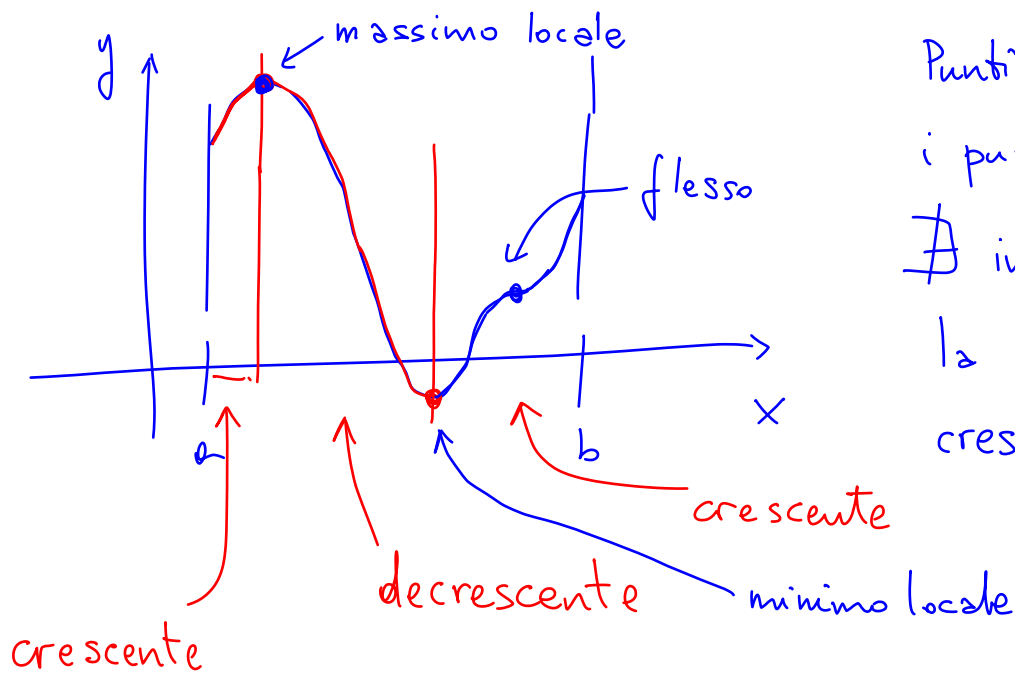

Punti stazionari: sono i punti \bar{x} tali che $f'(\bar{x}) = 0$ intorno di \bar{x} dove la funzione è o crescente o decrescente (massimi o minimi locali)

Terzo tipo di punto stazionario: flesso

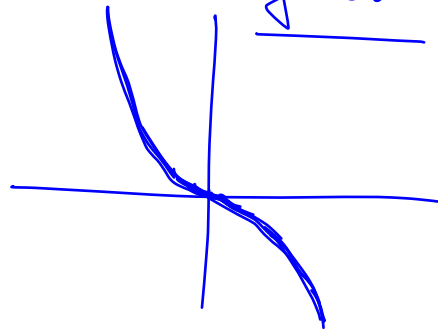
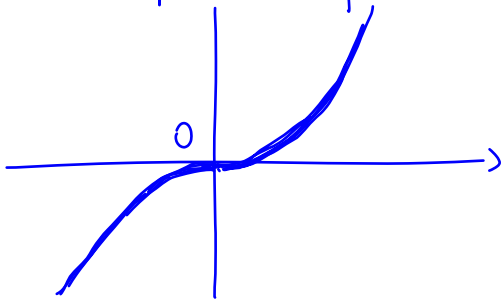

Funzioni polinomiali, esponenziali, logaritmiche,
trigonometriche

Operazioni tra funzioni: algebriche, composizione,
inversa

$$y = f(x) \quad f : D_f \rightarrow \mathbb{R}$$

$$y = g(x) \quad g : D_g \rightarrow \mathbb{R}$$

Somma: $y = f(x) + g(x) \quad f + g : D_f \cap D_g \rightarrow \mathbb{R}$

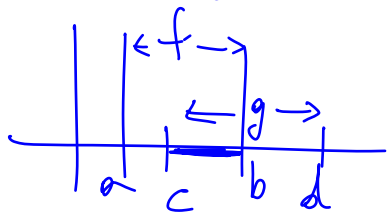

$$f : [a, b] \rightarrow \mathbb{R}$$
$$g : [c, d] \rightarrow \mathbb{R}$$

$$a < c < b < d$$

$$f + g : [c, b] \rightarrow \mathbb{R}$$

Prodotto : $y = f(x) \cdot g(x)$

$$f \cdot g : D_f \cap D_g \rightarrow \mathbb{R}$$

Quoziente : $y = \frac{f(x)}{g(x)}$

$$\frac{f}{g} : D_f \cap D_g \setminus \{x : g(x) = 0\} \rightarrow \mathbb{R}$$

Esempio : $f(x) = x$

$$g(x) = x$$

$$D_f = \mathbb{R}$$

$$D_g = \mathbb{R}$$

$$\frac{f(x)}{g(x)} = \frac{x}{x}$$

$$\frac{f}{g} : \mathbb{R} \setminus \{0\}$$

$$y = f(x)$$

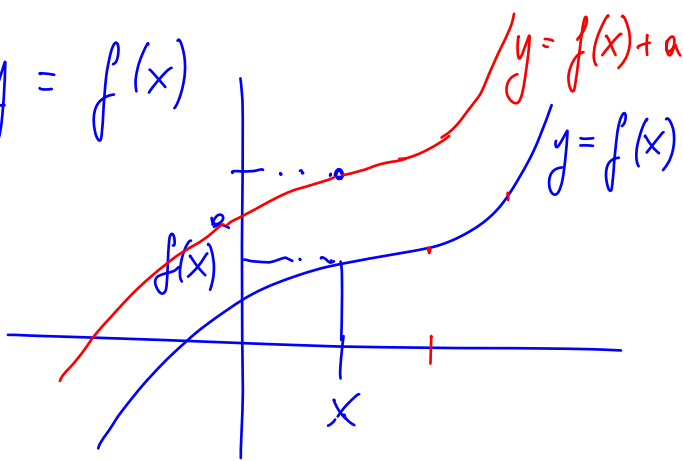

$$g(x) = a > 0$$

costante

$$y = f(x) + g(x) =$$
$$= f(x) + a$$

traslazione

$$y = f(x) \cdot g(x) = a f(x)$$

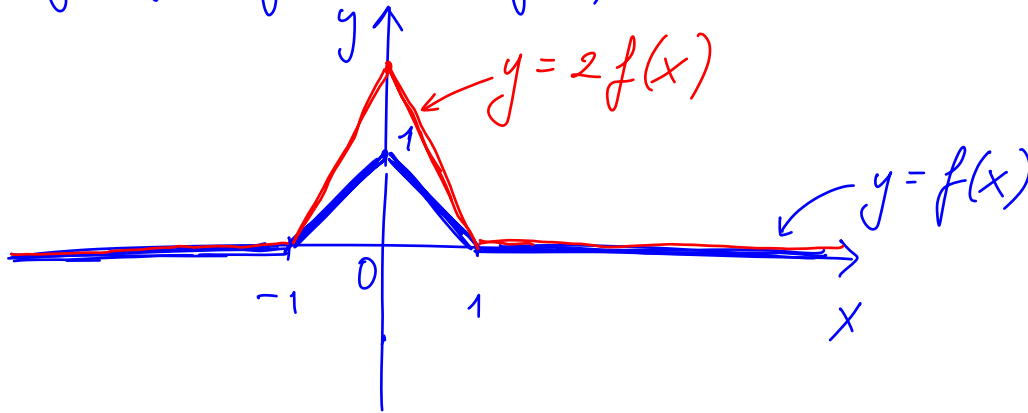

$$a = 2$$

fattore di
scala

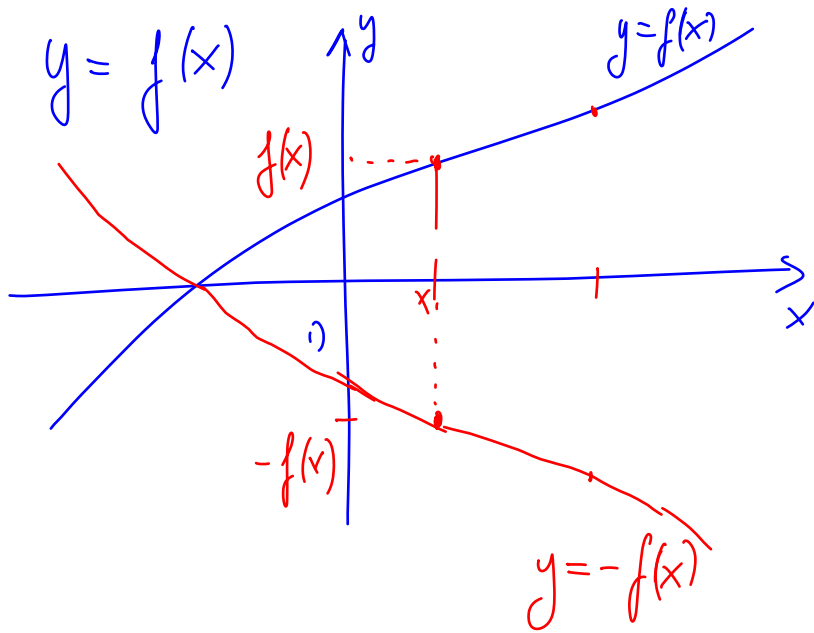

$$y = g(x) = -1$$

$$y = f(x) \cdot g(x) = -f(x)$$

riflessione rispetto all'asse x

Composizione di funzioni

$$f \circ g$$

$$y = f(g(x))$$

$$f: D_f \rightarrow \mathbb{R}$$

$$y = f(x)$$

$$g: D_g \rightarrow \mathbb{R}$$

$$y = g(x)$$

Esempio $y = f(x) = \sqrt{x}$ $D_f = \mathbb{R}_+$

$y = g(x) = x+2$ $D_g = \mathbb{R}$

$$y = f(g(x)) = \sqrt{g(x)} = \sqrt{x+2}$$

$$f \circ g = \sqrt{g} \quad f \circ g : [-2, \infty) \rightarrow \mathbb{R}$$

$$g \circ f \quad y = g(f(x)) = f(x) + 2 = \sqrt{x} + 2$$

$$g \circ f : \mathbb{R}_+ \quad f \circ g \neq g \circ f$$

La composizione di funzioni NON è commutativa

Esempio : $y = f(x)$ $y = g(x) = x + a$ $a = \text{costante} > 0$

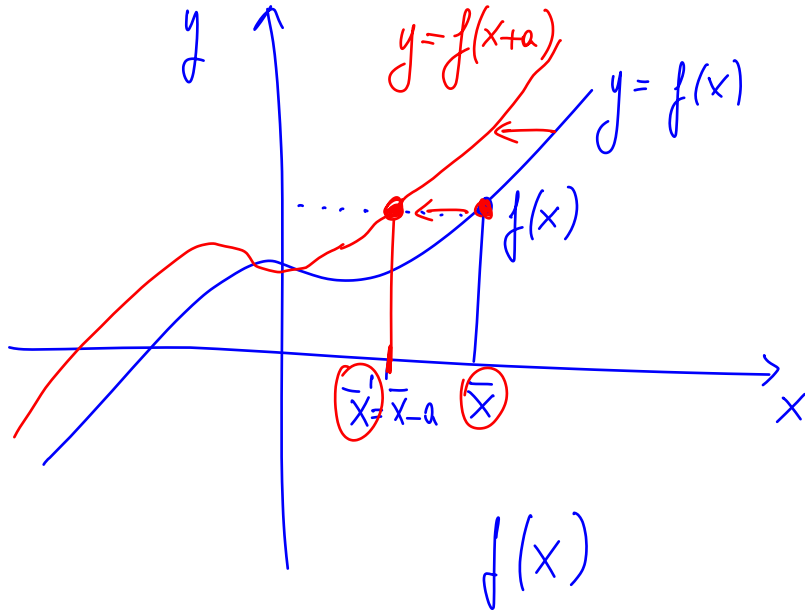

$f \circ g$

$$y = f(g(x)) = f(x+a)$$

traslazione (in x)

Quale punto \bar{x}' è tale che $f(\bar{x}' + a) = f(\bar{x})$?

$$\bar{x}' + a = \bar{x} \quad \bar{x}' = \bar{x} - a$$

$f(x+a)$ calcolata in \bar{x}' è $f(\bar{x}' + a) = f(\bar{x} - a + a) = f(\bar{x})$

$$y = f(x) \quad y = g(x) = -x$$

$$y = f(g(x)) = f(-x)$$

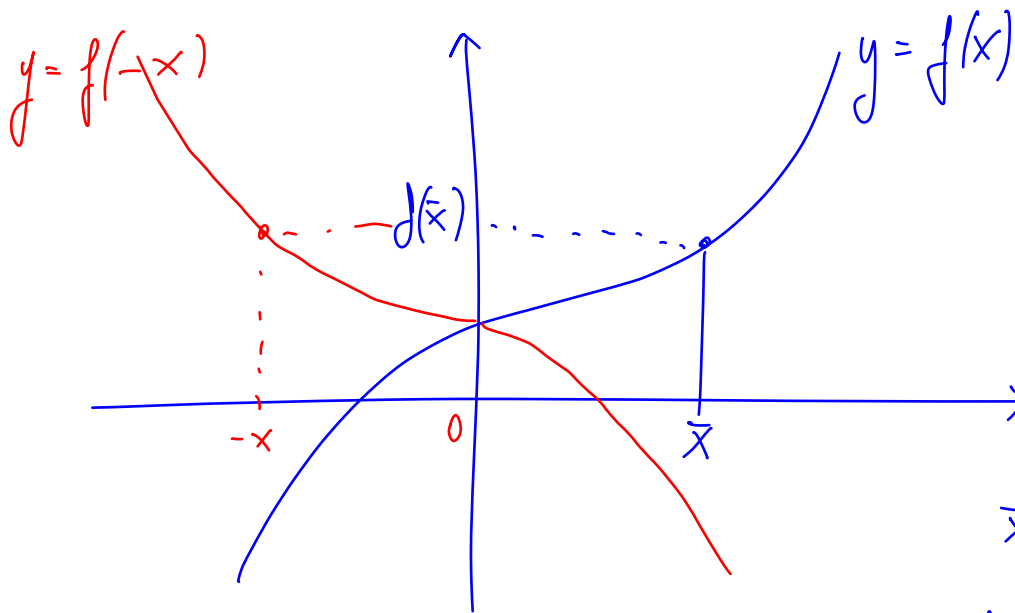

$$\bar{x} \quad \bar{x}' = -\bar{x}$$

$$y = f(x)$$

$$y = f(-x)$$

$$f(\bar{x}) = f(-\bar{x}')$$

Funzione inversa $y = f(x)$

cerco (se possibile) di risolvere questa come un'equazione per x data y

$$x = f^{-1}(y) \quad f^{-1} = \text{funzione inversa}$$

Poi scambio di nome x e y :

$$y = f^{-1}(x)$$

Esempio: $y = x^2 = f(x)$ $D_f = \mathbb{R}$

$y = x^2$ Dato y , quale x è tale che $y = x^2$?

Distinguiamo due casi:

1) $y < 0$: nessuna x tale che $y = x^2$

2) $y > 0$: $x = \sqrt{y}$ soddisfa $y = x^2 =$
 $= (\sqrt{y})^2 = y$

anche $x = -\sqrt{y}$ soddisfa $y = x^2 =$
 $= (-\sqrt{y})^2 = y$

Due funzioni inverse (scambio $x \leftrightarrow y$)

$$y = f^{-1}(x) = \begin{cases} \sqrt{x} \\ -\sqrt{x} \end{cases}$$

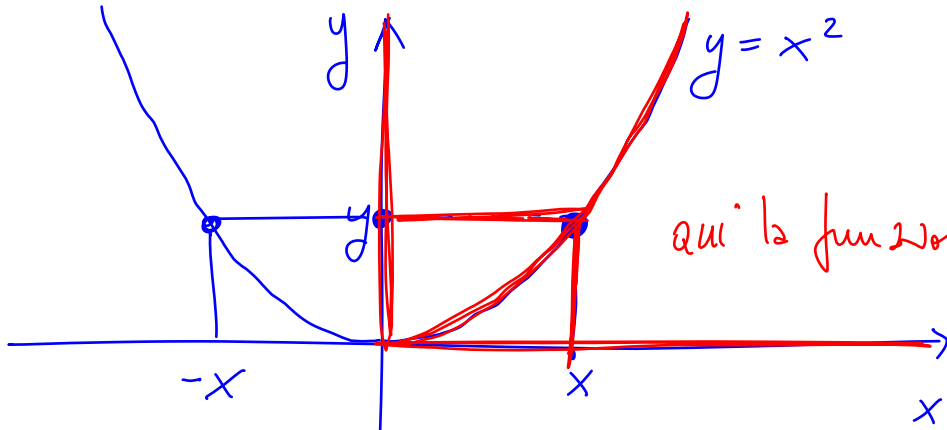

qui la funzione è biettiva

non è
 associato
 a nessuna x
 dal grafico

$$f: \mathbb{R}_+ \rightarrow \mathbb{R}_+ \quad y = x^2$$

$$f^{-1}: \mathbb{R}_+ \rightarrow \mathbb{R}_+ \quad y = \sqrt{x}$$

Verifica: f^{-1} è tale $f \circ f^{-1} = \text{identità}$

Deve valere $f(f^{-1}(x)) = f^{-1}(f(x)) = x$

$$y = x^2 = f(x) \quad x \in \mathbb{R}^+$$

$$y = \sqrt{x} = f^{-1}(x) = g(x) \quad f \circ g = g \circ f$$

$$\begin{aligned} y = f(g(x)) &= f(f^{-1}(x)) = (f^{-1}(x))^2 = \\ &= (\sqrt{x})^2 = x \end{aligned}$$

$$y = f^{-1}(f(x)) = \sqrt{f(x)} = \sqrt{x^2} = x$$

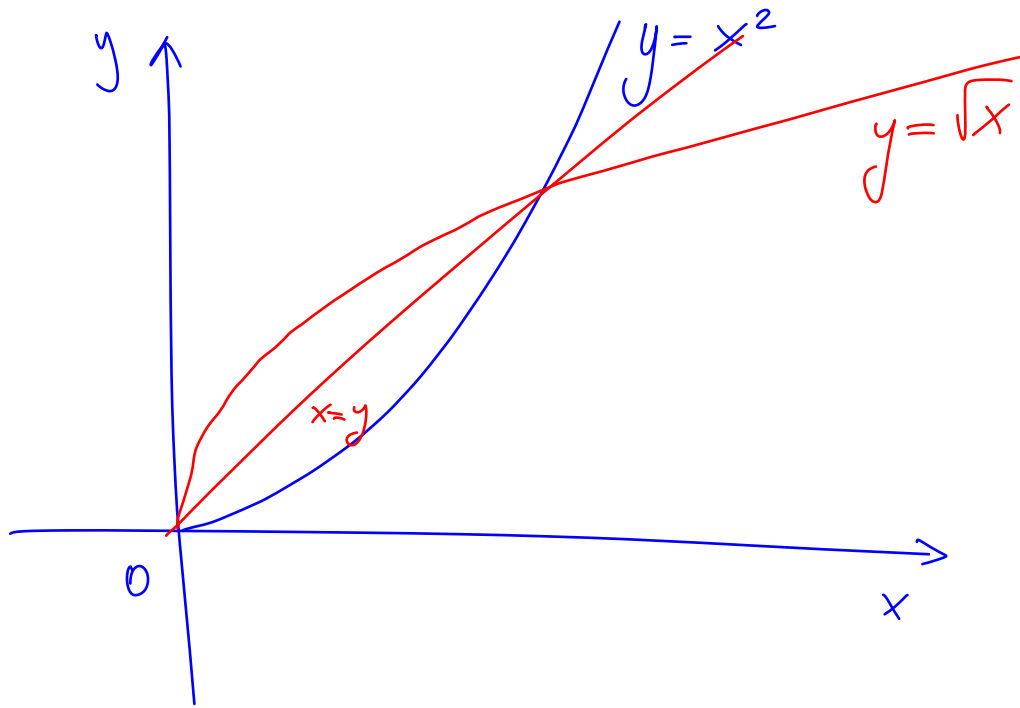

il grafico della funzione inversa è il riflesso
del grafico della funzione di partenza rispetto
alla diagonale $x=y$

Funzioni elementari

potenze

$$a^b = \underbrace{a \cdot \dots \cdot a}_{b \text{ volte}} \quad (b \in \mathbb{N})$$

$b \leftarrow$ esponente

\uparrow
base

a^b ha senso (si può definire) se

$$\longrightarrow \begin{cases} a > 0 & b \in \mathbb{R} \\ a = 0 & b > 0 & a^b = 0 \\ a < 0 & b = \frac{m}{n} & m, n \in \mathbb{Z} \\ & & n = \text{dispari} \end{cases}$$

$n \in \mathbb{N} \quad a > 0$:

$$a^n = \underbrace{a \cdot \dots \cdot a}_{n \text{ volte}}$$

$$a^{-n} = \frac{1}{a^n} = \frac{1}{\underbrace{a \cdot a \cdot \dots \cdot a}_{n \text{ volte}}}$$

$$2^{-3} = \frac{1}{2^3} = \frac{1}{2 \cdot 2 \cdot 2} = \frac{1}{8}$$

$a^{\frac{1}{n}}$ = radice n -esima di a , cioè quel $c > 0$

tale che $c^n = a$

$$8^{\frac{1}{3}} = 2 \quad \text{perché} \quad 2^3 = 8$$

$$a^{\frac{m}{n}} = \left(a^{\frac{1}{n}} \right)^m = \left(a^m \right)^{\frac{1}{n}} \quad m, n \in \mathbb{N}$$

$$\frac{m}{n} = m \cdot \frac{1}{n}$$

Proprietă :
$$\underline{a^{b+c} = a^b \cdot a^c} \quad a > 0$$

$$2^{10} = \underbrace{2 \cdot 2 \cdot 2 \cdot 2 \cdot 2 \cdot 2 \cdot 2 \cdot 2 \cdot 2 \cdot 2}_{= 2^3 \cdot 2^7} =$$



$$= 2^3 \cdot 2^7$$

$$= 2^{3+7}$$

$$\underline{a^{b \cdot c} = (a^b)^c = (a^c)^b}$$

$$2^{10} = 2^{2 \cdot 5} = (2^2)^5 = (2 \cdot 2)^5 =$$

$$= (2 \cdot 2) \cdot (2 \cdot 2) \cdot (2 \cdot 2) \cdot (2 \cdot 2) \cdot (2 \cdot 2)$$

$$a^0 = 1 \quad \forall a > 0$$

$$a^b = a^{b+0} = a^b \cdot a^0 \quad \Rightarrow \quad a^0 = 1$$

a^0 è l'elemento neutro della moltiplicazione, cioè 1

a^b ci permette di costruire due funzioni

$$y = a^x$$

a dato

:

funzione
esponenziale

$$y = x^b$$

b dato

:

funzione potenza

$$y = x^b$$

$$b = 2, \frac{1}{2}, \frac{1}{3}$$

$$y = x^2$$

$$y = x^{\frac{1}{2}} = \sqrt{x}$$

$$y = \sqrt[3]{x} \\ = x^{\frac{1}{3}}$$

...

$$y = a^x$$

funzione esponenziale

$$a > 1$$

$$a = 2$$

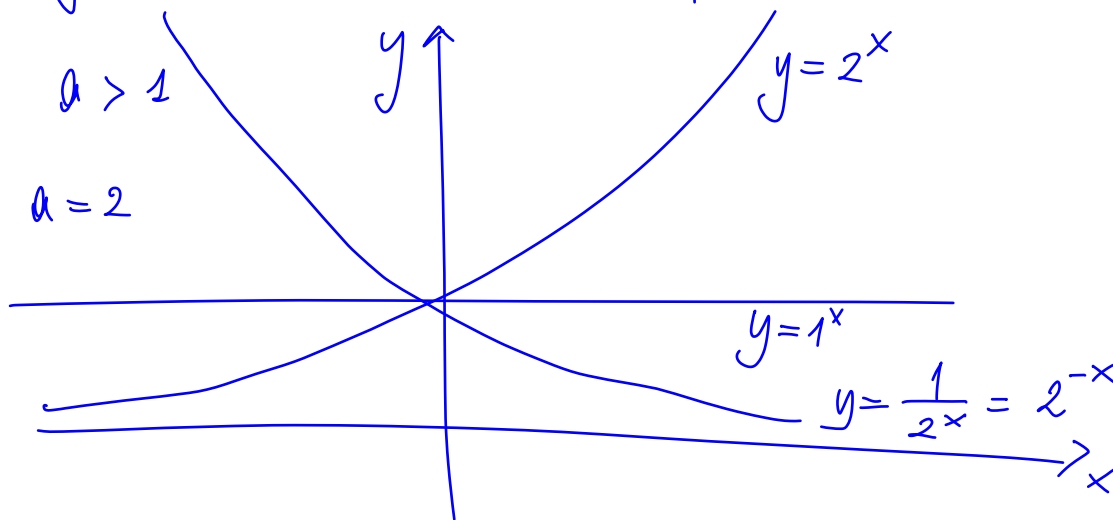

$$a = 1:$$

$$y = 1^x = 1$$

$a < 1$: decrescita esponenziale

Costante di Eulero $e = 2.718\dots$

base canonica per la funzione esponenziale

$$y = e^x$$

Logaritmo : l'inversa della funzione esponenziale

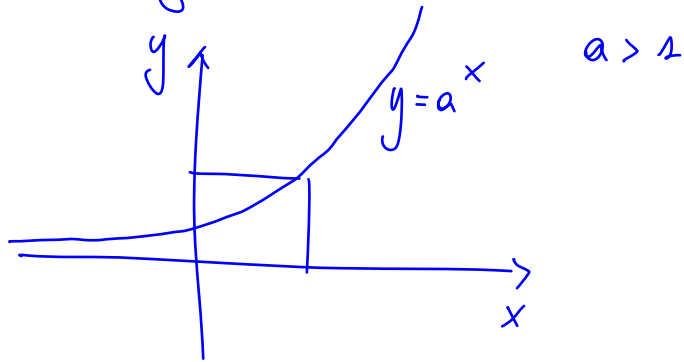

$$y = a^x : \mathbb{R} \rightarrow \mathbb{R}_+$$

$$\log : \mathbb{R}_+ \rightarrow \mathbb{R}$$

$$y = a^x \quad \text{vuol dire} \quad \Leftrightarrow$$

$$x = \log_a y$$

$$\log_2 8 \stackrel{?}{=} 3$$

$$8 = 2^?$$

$$\log_2 1024 = 10$$

$$2^{10} = 1024$$

$$2 \cdot 2 = 4$$

$$2 \cdot 2 \cdot 2 = 8$$

$$2, 4, 8, 16, 32, 64,$$

$$128, 256, 512, 1024$$

\log_e : logaritmo naturale \ln

$$\log_{10} (\text{1miliardo}) = \log_{10} 10^9 = 9$$

mille	10^3	Kilo
1 milione	10^6	Mega
1 miliardo	10^9	Giga

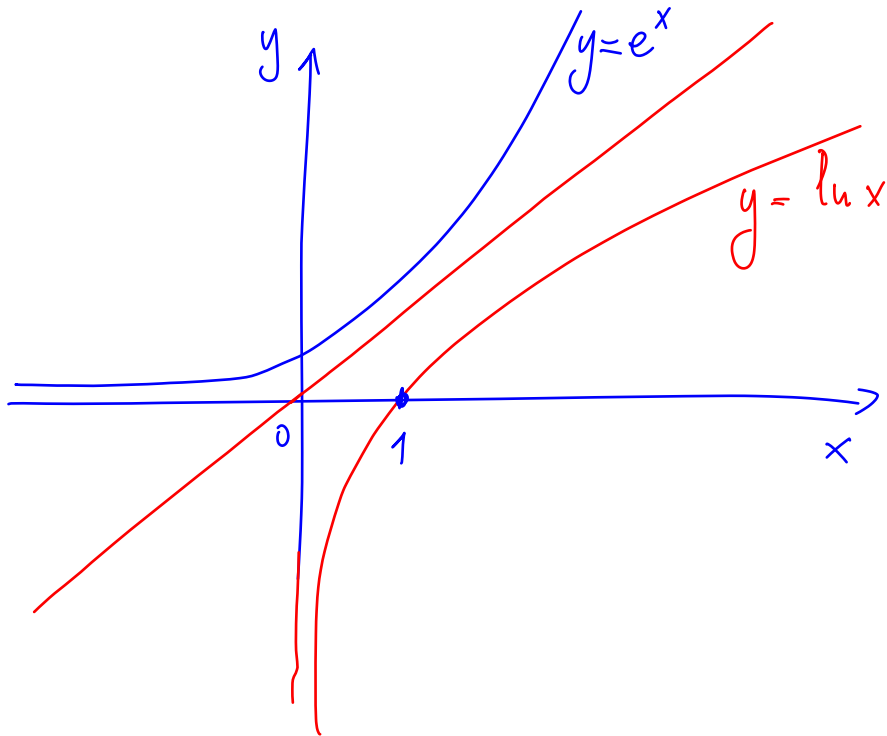

$$y = a^x$$

$$e^{\ln a} = a$$

$$y = f(x) = e^x$$

$$y = \underline{\ln x = f^{-1}(x)}$$

$$f(f^{-1}(x)) = x$$

$$e^{\overset{||}{f^{-1}(x)}} = e^{\ln x} = x \quad \leftarrow$$

$$f^{-1}(f(x)) = x = \ln f(x) = \ln e^x$$

$$x = \ln e^x = \log_e e^x$$

$$x = e^{\ln x}$$

$$\log_a 1 = ? = 0$$

$$a^? = 1$$

$$\log_a a = 1 \quad a^1 = a \quad a^1 = a$$

$$\left\{ \begin{array}{l} \log_a (b \cdot c) = \log_a b + \log_a c \\ \log_a \frac{1}{b} = -\log_a b \quad ** \end{array} \right.$$

$$a^{b+c} = a^b \cdot a^c$$

$$\log_a (b \cdot c) = s \quad \log_a b = t \quad \log_a c = u$$

$$s = t + u$$

$$b \cdot c = a^s \quad b = a^t \quad c = a^u$$

$$a^s = b \cdot c = a^t \cdot a^u = a^{t+u}$$

$$\underline{\underline{s = t + u}}$$

$$\log_a \frac{1}{b} + \log_a b = \log_a \left(\frac{1}{b} \cdot b \right) = \log_a 1 = 0$$

$$\Rightarrow \log_a \frac{1}{b} = -\log_a b$$

$$a^{b \cdot c} = (a^b)^c = (a^c)^b$$

Cambio di base

$$y = \underbrace{\log_a x}_s = \left(\underbrace{\log_a b}_t \right) \cdot \underbrace{\log_b x}_u \quad s = t \cdot u$$

$$x = a^s$$

$$a^t = b$$

$$b^u = x$$

$$a^s = x = b^u = (a^t)^u = a^{t \cdot u} \Rightarrow s = t \cdot u$$

Funzioni trigonometriche

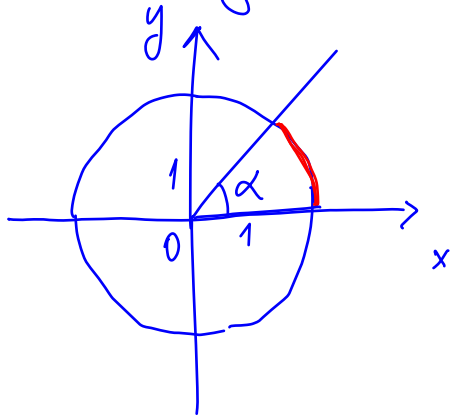

α si può misurare in gradi

360° : angolo giro

180° : angolo piatto

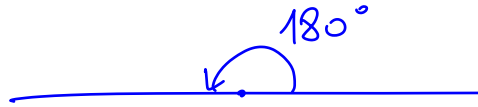

90° :



45°

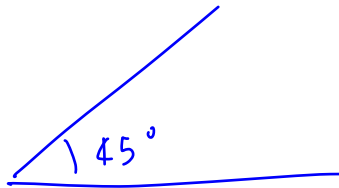

in radianti

misura dell'angolo: lunghezza dell'arco di circonferenza
di raggio 1 sottesa dall'angolo

angolo giro: lunghezza della circonferenza di
raggio 1 = 2π

$$360^\circ \leftrightarrow 2\pi$$

$$180^\circ \leftrightarrow \pi$$

$$90^\circ \leftrightarrow \frac{\pi}{2}$$

angolo in gradi =

$$= \frac{360^\circ}{2\pi} (\text{angolo in radianti})$$

$$\text{angolo in radianti} = \frac{2\pi}{360^\circ} \cdot (\text{angolo in gradi})$$

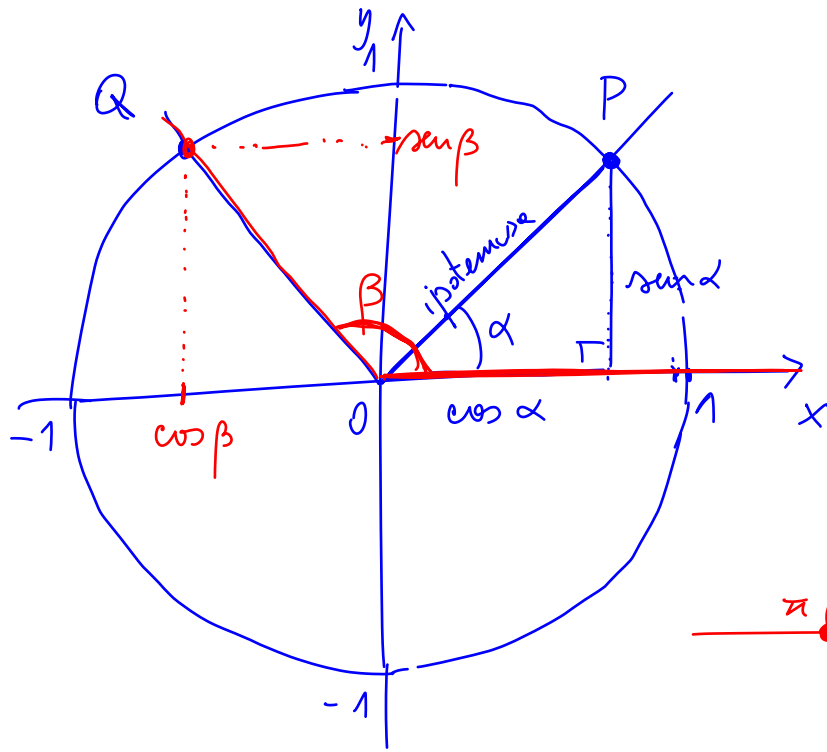

$$P = (\cos \alpha, \text{sen } \alpha)$$

$$Q = (\cos \beta, \text{sen } \beta)$$

semi-asse x positivo

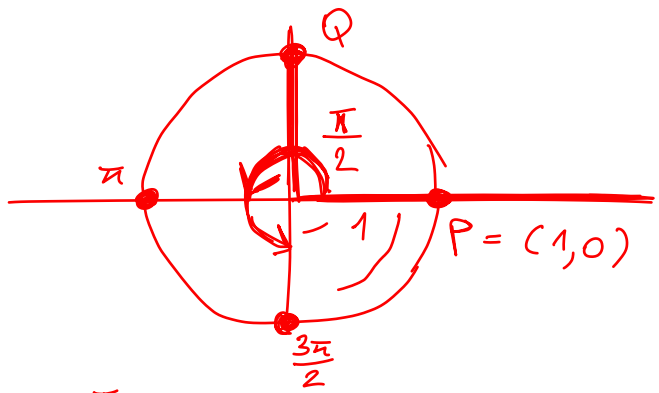

$$\text{sen } 0 = 0$$

$$\text{sen } \frac{\pi}{2} = 1$$

$$\text{sen } \pi = 0$$

$$\cos 0 = 1$$

$$\cos \frac{\pi}{2} = 0$$

$$\cos \pi = -1$$

$$\text{sen } \frac{3\pi}{2} = -1 = \text{sen} \left(-\frac{\pi}{2} \right)$$

$$\cos \frac{3\pi}{2} = 0 = \cos \left(-\frac{\pi}{2} \right)$$

$$y = \sin x$$

$$y = \cos x$$

$$D = \mathbb{R}$$

$$D = \mathbb{R}$$

sono funzioni periodiche di periodo 2π

$$\sin(x + 2\pi) = \sin(x)$$

$$\cos(x + 2\pi) = \cos(x)$$

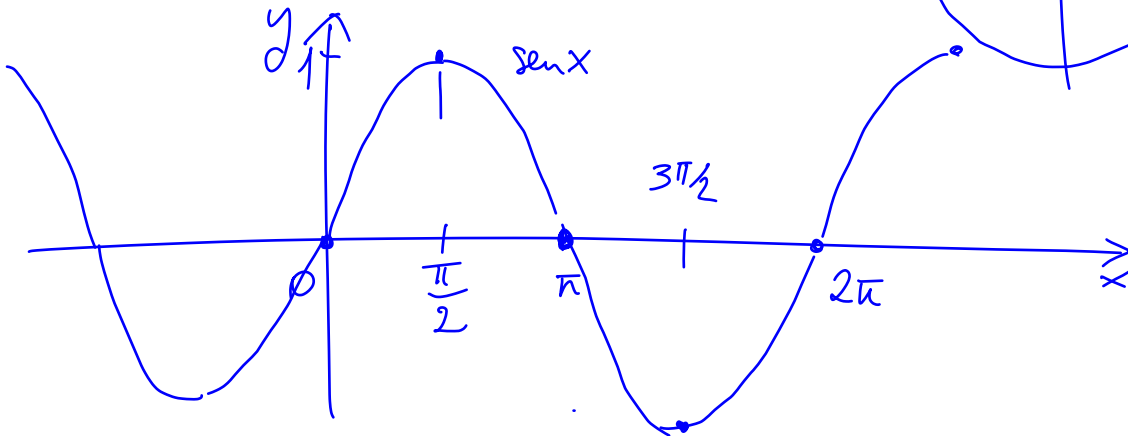
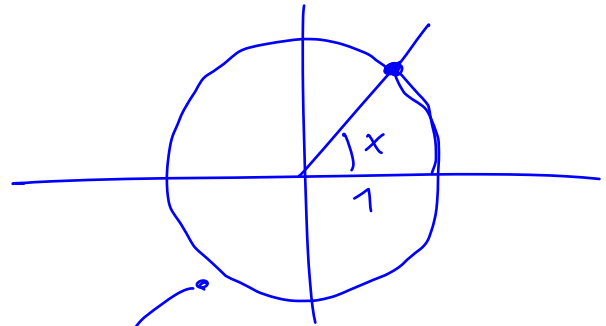

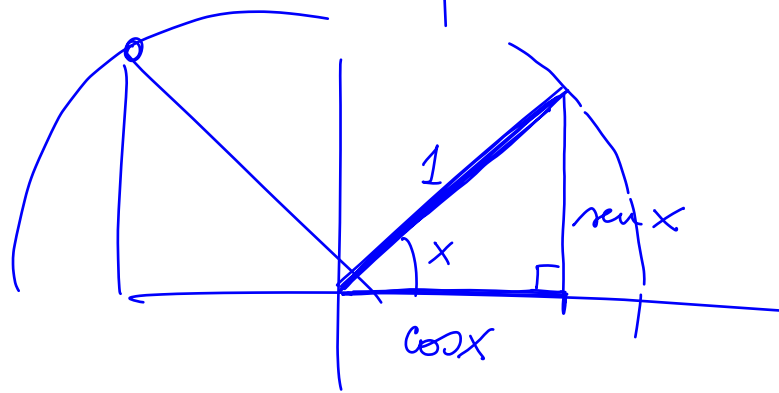
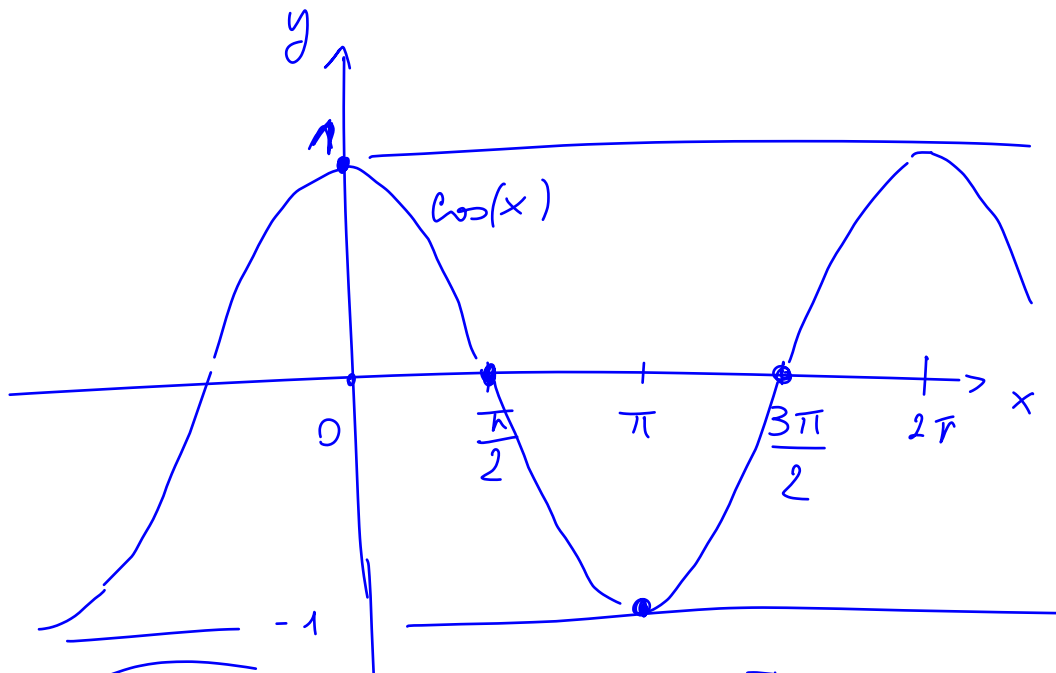

Teorema di Pitagora

$$1^2 = (\sin x)^2 + (\cos x)^2$$

Vale sempre

Si scrive anche

$$\boxed{\sin^2(x) + \cos^2(x) = 1} \quad \swarrow$$

$\sin^2(x)$ vuol dire $\sin(x) \cdot \sin(x)$
o sia $(\sin x)^2$

NON È $\sin(x^2)$!!!

$$f(x^2) \neq (f(x))^2$$

$$\alpha = \frac{\pi}{4}$$

45°

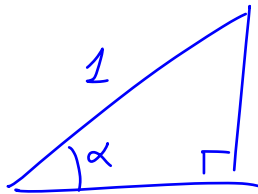

$$\sin \frac{\pi}{4} = ?$$

$$\cos \frac{\pi}{4} = ?$$

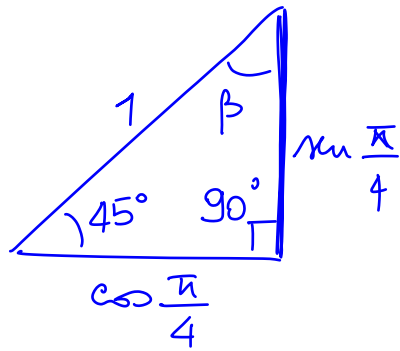

$$\beta = 45^\circ = \frac{\pi}{4}$$

La somma degli angoli interni di un triangolo è 180° , cioè π

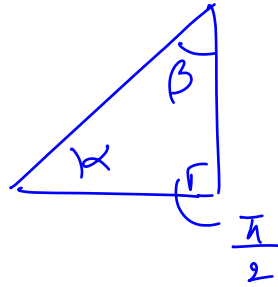

$$\alpha + \beta + \frac{\pi}{2} = \pi$$

$$\alpha + \beta = \frac{\pi}{2}$$

Se $\alpha = \frac{\pi}{4}$

$$\alpha + \beta = \frac{\pi}{2} = \frac{\pi}{4} + \beta$$

trovo $\beta = \frac{\pi}{4}$

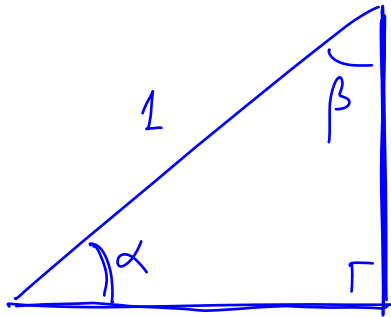

$$\sin \alpha = \cos \beta$$

$$\alpha + \beta = \frac{\pi}{2}$$

$$\beta = \frac{\pi}{2} - \alpha$$

$$\begin{cases} \cos \left(\frac{\pi}{2} - \alpha \right) = \sin \alpha \\ \sin \left(\frac{\pi}{2} - \alpha \right) = \cos \alpha \end{cases}$$

$$\begin{aligned} \sin \frac{\pi}{4} &= \cos \frac{\pi}{4} = \sqrt{\frac{1}{2}} = \frac{1}{\sqrt{2}} \\ &= \frac{\sqrt{2}}{2} \end{aligned}$$

$$\alpha = \frac{\pi}{4} :$$

$$\cos \left(\frac{\pi}{2} - \frac{\pi}{4} \right) = \cos \frac{\pi}{4} = \sin \frac{\pi}{4}$$

$$1 = \left(\sin \frac{\pi}{4} \right)^2 + \left(\cos \frac{\pi}{4} \right)^2 = 2 \left(\sin \frac{\pi}{4} \right)^2 \quad \left(\sin \frac{\pi}{4} \right)^2 = \frac{1}{2}$$

$$\sqrt{\frac{1}{2}} = \frac{1}{\sqrt{2}} = \frac{\sqrt{2}}{\sqrt{2}} \cdot \frac{1}{\sqrt{2}} = \frac{\sqrt{2}}{2}$$

$$\left(\sqrt{\frac{1}{2}}\right)^2 = \frac{1}{2}$$

$$\left(\frac{1}{\sqrt{2}}\right)^2 = \frac{1}{\sqrt{2}} \cdot \frac{1}{\sqrt{2}} = \frac{1}{2}$$

	α	$\cos \alpha$	$\sin \alpha$
	0	1	0
30°	$\frac{\pi}{6}$	$\frac{\sqrt{3}}{2}$	$\frac{1}{2}$
45°	$\frac{\pi}{4}$	$\frac{\sqrt{2}}{2}$	$\frac{\sqrt{2}}{2}$
60°	$\frac{\pi}{3}$	$\frac{1}{2}$	$\frac{\sqrt{3}}{2}$

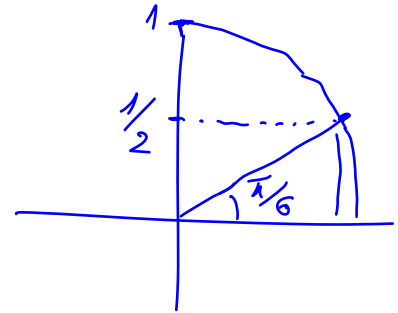

$$\forall x : \quad -1 \leq \sin(x) \leq 1$$

$$-1 \leq \cos(x) \leq 1$$

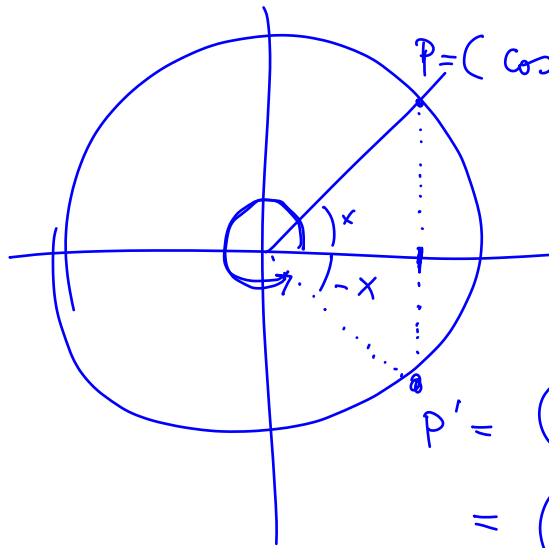

$$P = (\cos x, \sin x)$$

$$P' = (\cos x, -\sin x)$$

$$= (\cos(-x), \sin(-x))$$

$$= (\cos(2\pi - x), \sin(2\pi - x))$$

$$\cos(-x) = \cos(x)$$

$$\sin(-x) = -\sin(x)$$

simmetrico sotto riflessioni
rispetto all'asse y

funzione
pari

simmetrico sotto riflessioni
rispetto all'origine

funzione
dispari

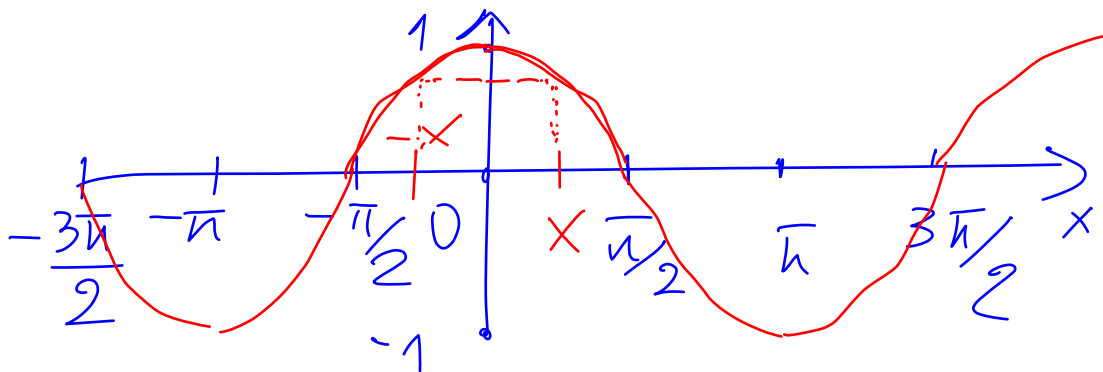

$\cos(x)$

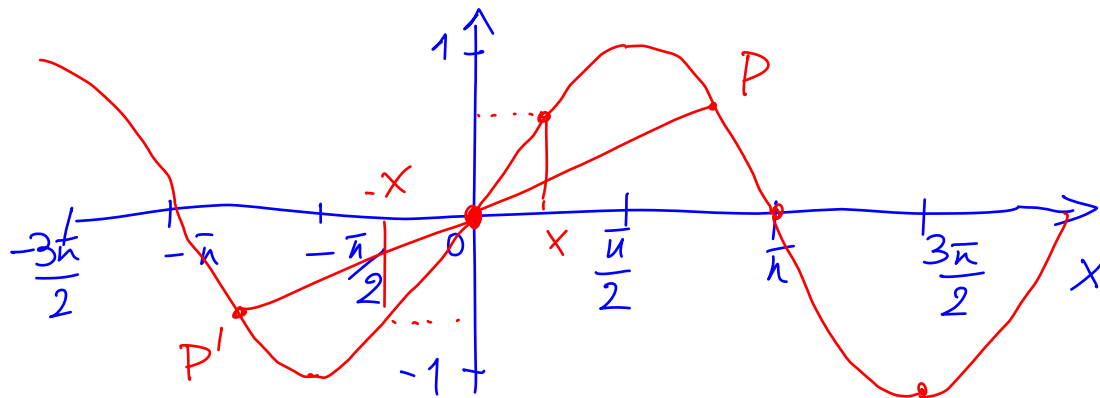

$\sin(x)$

Si dice pari una funzione $f(x)$ tale che

$$f(-x) = f(x)$$

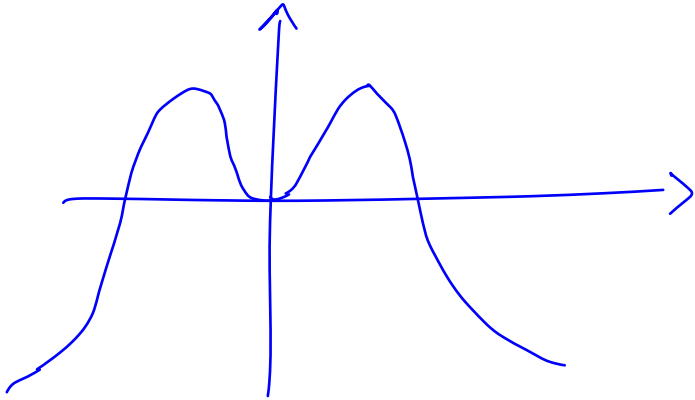

$$y = x^2 - x^4$$

Si dice dispari una funzione $f(x)$ tale che

$$f(-x) = -f(x)$$

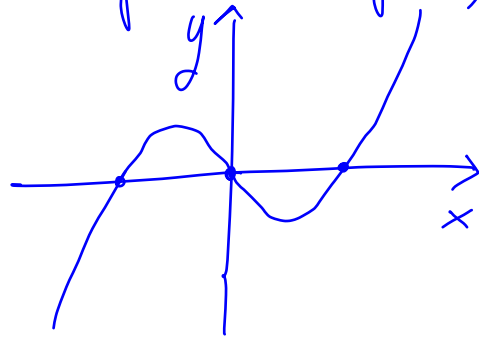

$$y = x^3 - x$$

Identità notevoli:

$$\begin{cases} \sin(\alpha + \beta) = \sin(\alpha) \cdot \cos(\beta) + \sin(\beta) \cos(\alpha) \\ \cos(\alpha + \beta) = \cos(\alpha) \cos(\beta) - \sin(\alpha) \sin(\beta) \end{cases}$$

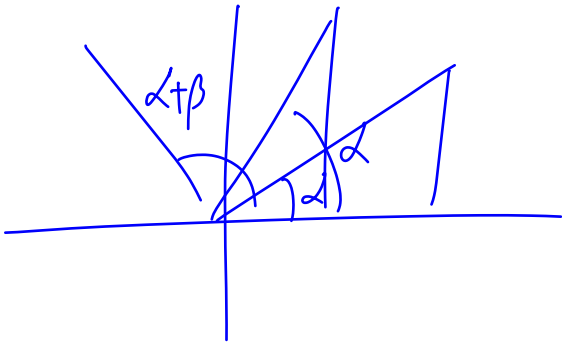

$$\begin{cases} \cos\left(\frac{\pi}{2} - \alpha\right) = \sin \alpha \quad \leftarrow \\ \sin\left(\frac{\pi}{2} - \alpha\right) = \cos \alpha \quad \leftarrow \end{cases}$$

Verifica $\alpha \rightarrow \frac{\pi}{2}$

$$\begin{cases} \sin\left(\frac{\pi}{2} + \beta\right) = \cos \beta \\ \cos\left(\frac{\pi}{2} + \beta\right) = -\sin \beta \end{cases}$$

$\beta \rightarrow -\alpha$

$$\sin\left(\frac{\pi}{2} - \alpha\right) = \cos(-\alpha) = \cos \alpha$$

$$\cos\left(\frac{\pi}{2} - \alpha\right) = -\sin(-\alpha) = \sin \alpha$$

Tangente

$$\operatorname{tg}(x) = \frac{\sin(x)}{\cos(x)}$$

$$\operatorname{ctg}(x) = \frac{\cos(x)}{\sin(x)}$$

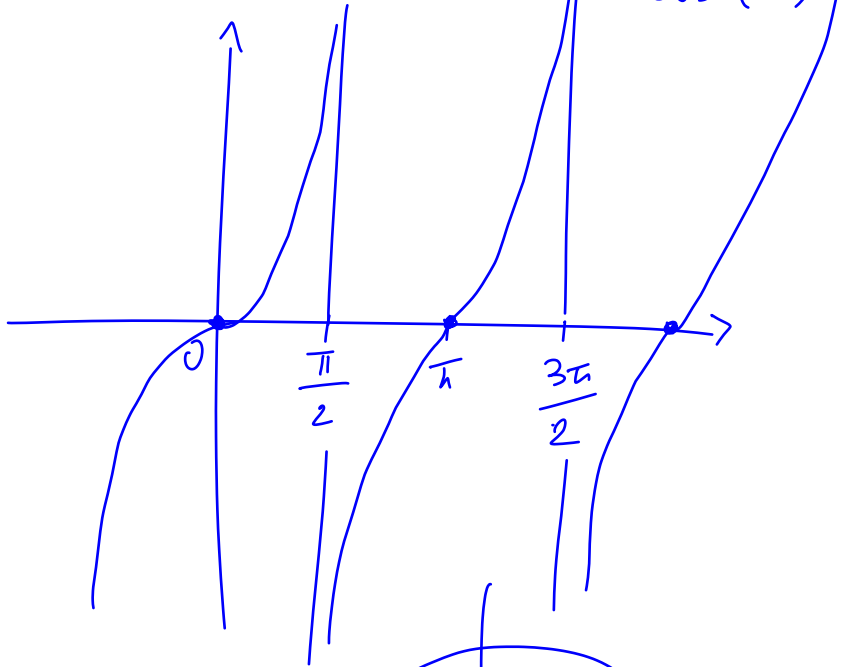

$$\operatorname{tg}(0) = \frac{\sin(0)}{\cos(0)} = \frac{0}{1} = 0$$

$$\operatorname{tg}(\pi) = \frac{\sin(\pi)}{\cos(\pi)} = \frac{0}{-1} = 0$$

$$\operatorname{tg}\left(\frac{\pi}{2}\right) = \frac{\sin\left(\frac{\pi}{2}\right)}{\cos\left(\frac{\pi}{2}\right)} = \frac{1}{0} = ?$$

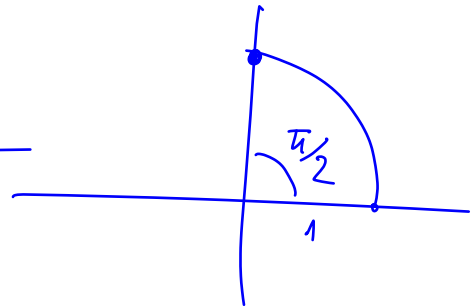
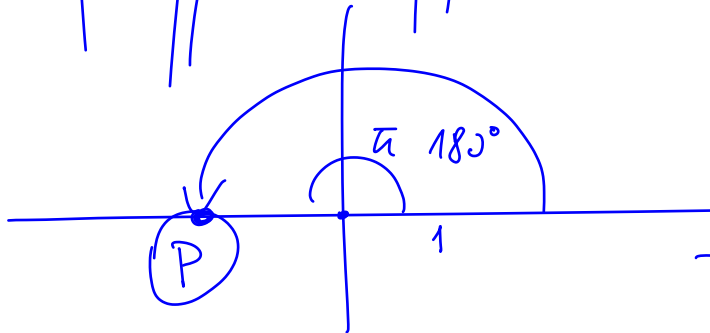

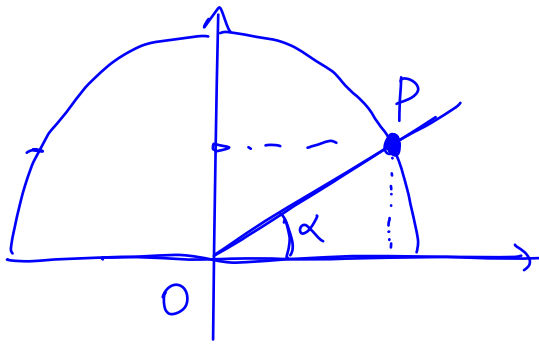

$\text{tg}(\alpha)$: pendenza delle
retta OP

Funzioni inverse

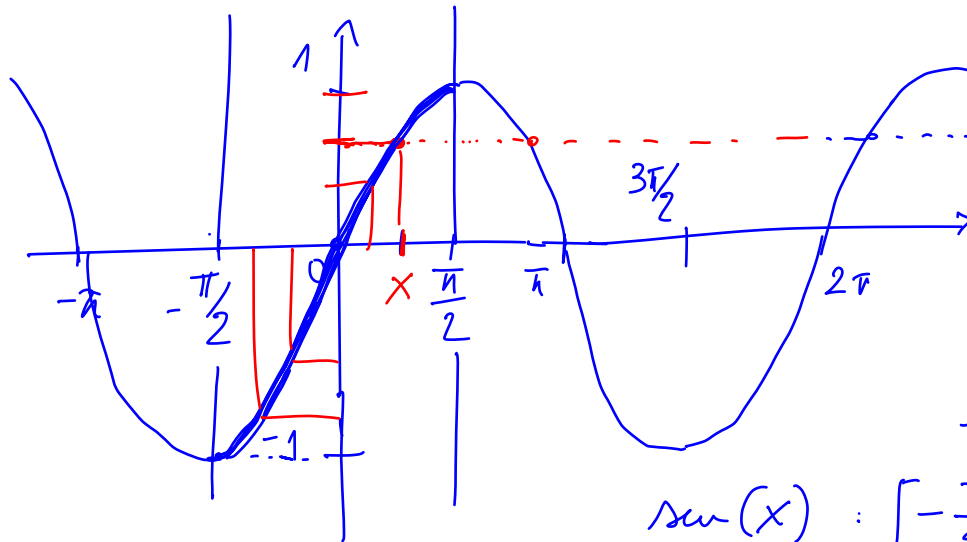

Ci sono infinite
ascisse colla
stessa ordinata

\bar{e} invertibile \supset

$$\sin(x) : \left[-\frac{\pi}{2}, \frac{\pi}{2}\right] \rightarrow [-1, 1]$$

L'inversa si chiama arcseno

$$y = \arcsin(x) \quad : \quad [-1, 1] \longrightarrow \left[-\frac{\pi}{2}, \frac{\pi}{2}\right]$$

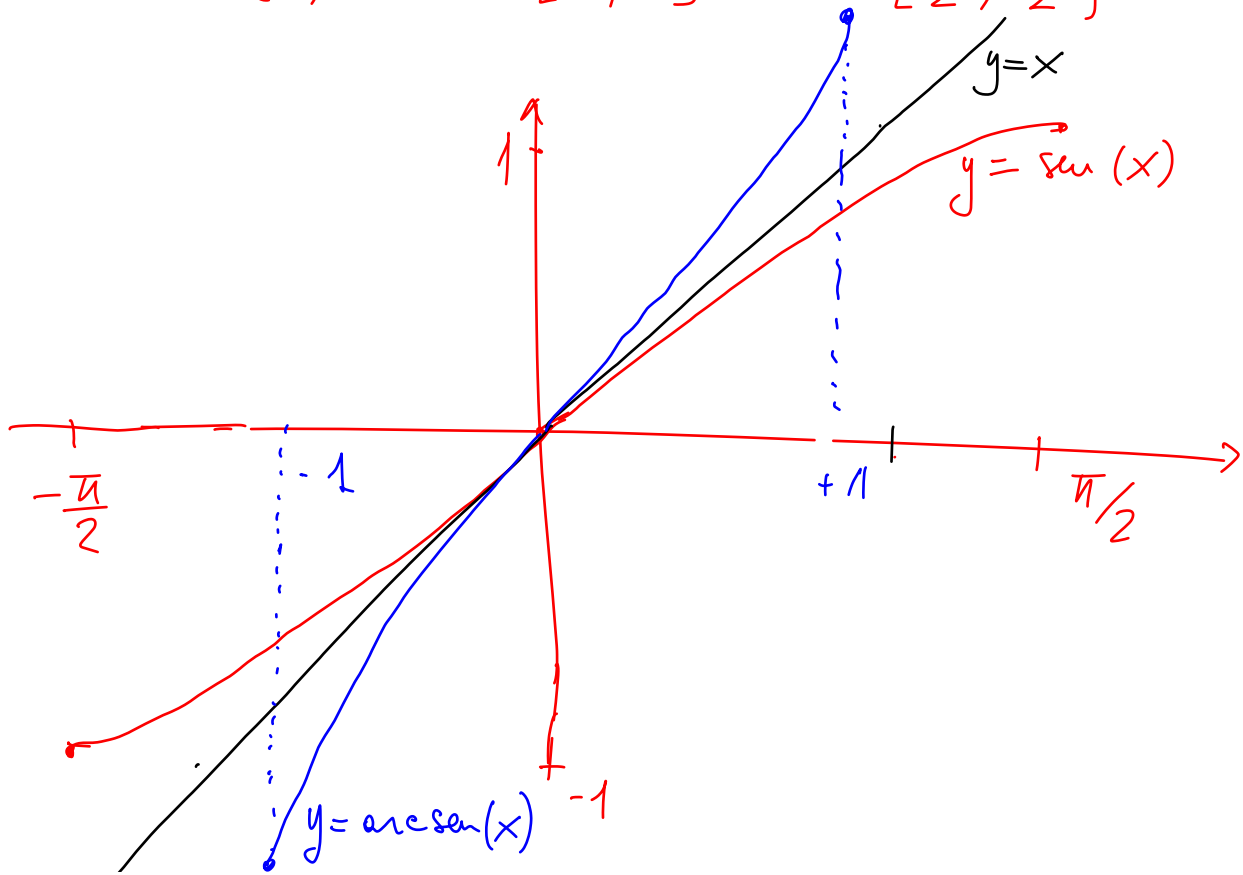

L'inversa del coseno è definita in $[-1, 1] \rightarrow [0, \pi]$

$$\cos(x): [0, \pi] \rightarrow [-1, 1]$$

$$\arccos(x): [-1, 1] \rightarrow [0, \pi]$$

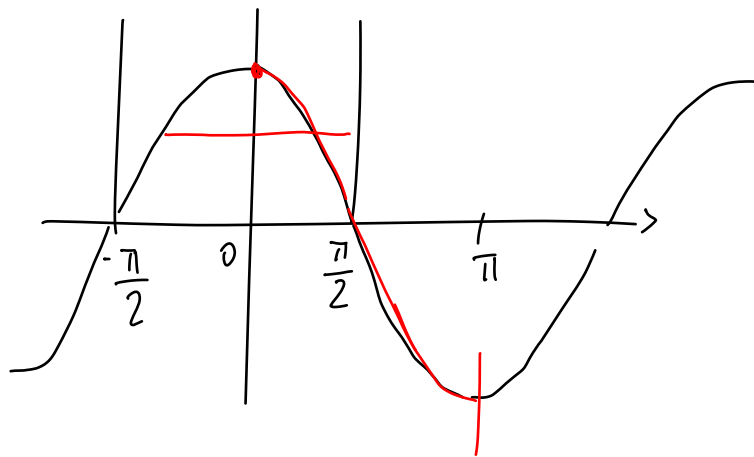

LIMITI

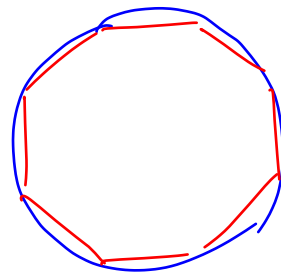
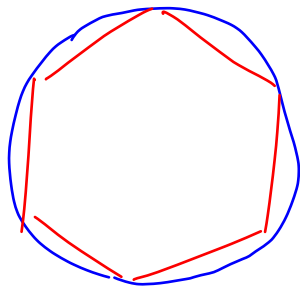
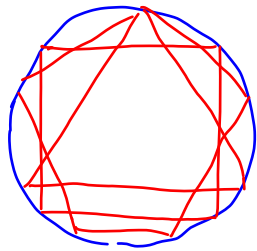

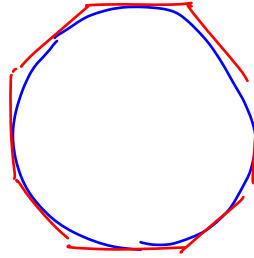
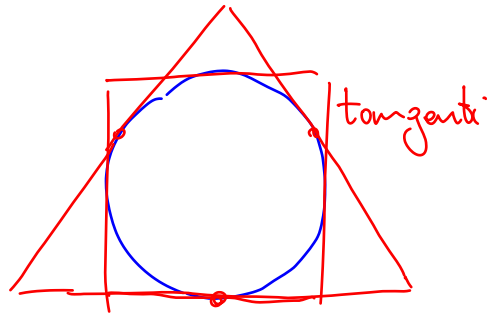

Archimede:
(circonferenza
di raggio 1)

circonferenza $>$ perimetri di tutti
i poligoni regolari
inscritti

circonferenza $<$ perimetri di tutti i poligoni
regolari circoscritti

\exists un solo numero (2π) che ha queste proprietà
 $\pi = 3.14$

Successione

$$a_n : \mathbb{N}_+ \rightarrow \mathbb{R}$$

"f(n)"

$$a_n = \frac{1}{n}$$

$$a_1 = 1 \quad a_2 = \frac{1}{2} \quad a_3 = \frac{1}{3}$$

$$a_4 = \frac{1}{4} \quad \dots \quad a_{10} = \frac{1}{10} \quad \dots \quad a_{100} = \frac{1}{100}$$

$$a_{1000} = \frac{1}{1000} \quad \dots \quad a_{1000000} = \frac{1}{1000000}$$

$$\lim_{n \rightarrow \infty} \frac{1}{n} = 0$$

Definizione di limite di una successione

Si dice $\lim_{n \rightarrow \infty} a_n = l$ se

$\forall \varepsilon > 0 \quad \exists N \quad / \quad \forall n > N \quad |a_n - l| < \varepsilon$
(arbitrariamente piccolo) = "da un certo punto (che è N) in poi" "modulo di x "
 $|x| =$ "valore assoluto di x "

$$|x| = \begin{cases} x & \text{se } x > 0 \\ -x & \text{se } x < 0 \end{cases}$$

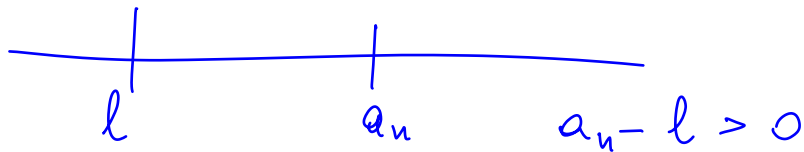
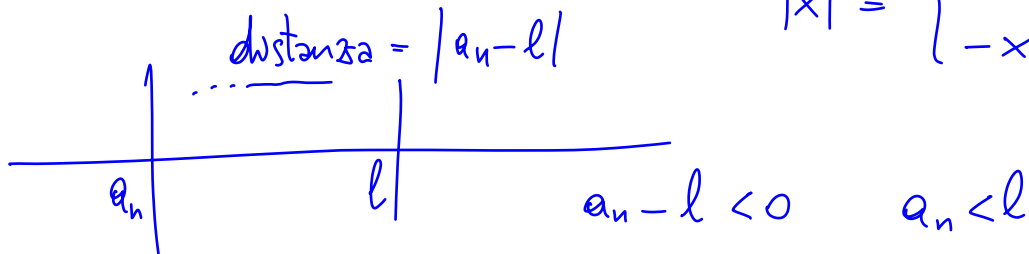

$$\lim_{n \rightarrow \infty} \frac{1}{n} = 0 \quad a_n = \frac{1}{n} \quad l = 0$$

Sia $\varepsilon > 0$ Domanda: $\exists N / \forall n > N$

$$|a_n - l| = |a_n| = \left| \frac{1}{n} \right| = \frac{1}{n} < \varepsilon?$$

$$\forall n > N \quad \frac{1}{n} < \varepsilon \quad \begin{array}{l} \text{moltiplica per } n: \quad 1 < n\varepsilon \\ \text{moltiplica per } \frac{1}{\varepsilon}: \quad \frac{1}{\varepsilon} < n \end{array}$$

$$a < b \iff \lambda a < \lambda b \quad (\lambda > 0)$$

$$\iff \sigma a > \sigma b \quad (\sigma < 0)$$

Basta scegliere $N = \frac{1}{\varepsilon}$:

$\forall n > N$ (cioè $n > \frac{1}{\varepsilon}$) è vero che $\frac{1}{n} < \varepsilon$

$$\lim_{n \rightarrow \infty} \frac{1}{n} = 1 \quad ?$$

$$\text{dato } \varepsilon > 0 \quad \exists N / \forall n > N \quad \left| a_n - l \right| < \varepsilon \quad ?$$

$$\left| \underbrace{\frac{1}{n} - 1} \right| < \varepsilon \quad 1 - \frac{1}{n} < \varepsilon \quad \text{impossibile}$$

$$\underbrace{1 - \frac{1}{n}} \text{ sempre } \geq 0 \quad (n = 1, 2, 3, \dots)$$

aggiungiamo $\frac{1}{n}$: $1 < \varepsilon + \frac{1}{n}$ $1 - \varepsilon < \frac{1}{n}$
e sottriamo ε

impossibile: scelgo per es. $\varepsilon = \frac{1}{10}$

dovrebbe
essere

$$1 - \frac{1}{10} < \frac{1}{n}$$

$\forall n > N$
contraddizione

$$\frac{9}{10} < \frac{1}{n}$$

$$n < \frac{10}{9}$$

Limite di una funzione $f(x)$

$$\lim_{x \rightarrow x_0} f(x) = l \quad \text{se}$$

"limite di $f(x)$ per x che tende a x_0 "

$$\forall \varepsilon > 0 \quad \exists \delta > 0 \quad / \quad \forall x \quad |x - x_0| < \delta \quad |f(x) - l| < \varepsilon$$

$x \neq x_0$

Una funzione è continua in x_0 se

$$\lim_{x \rightarrow x_0} f(x) = f(x_0)$$

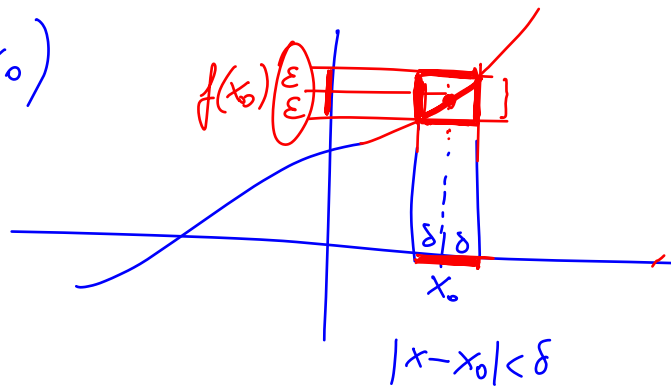

$|x - x_0| < \delta$ si scrive anche

$$x_0 - \delta < x < x_0 + \delta$$

compreso fra
 $x_0 - \delta$ e $x_0 + \delta$

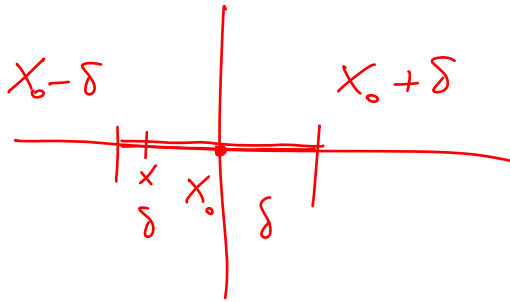

$\{ x : x_0 - \delta < x < x_0 + \delta \} =$ intorno di x_0
(di grandezza δ)

è l'intervallo $(x_0 - \delta, x_0 + \delta)$

aperto (= gli estremi NON sono inclusi)

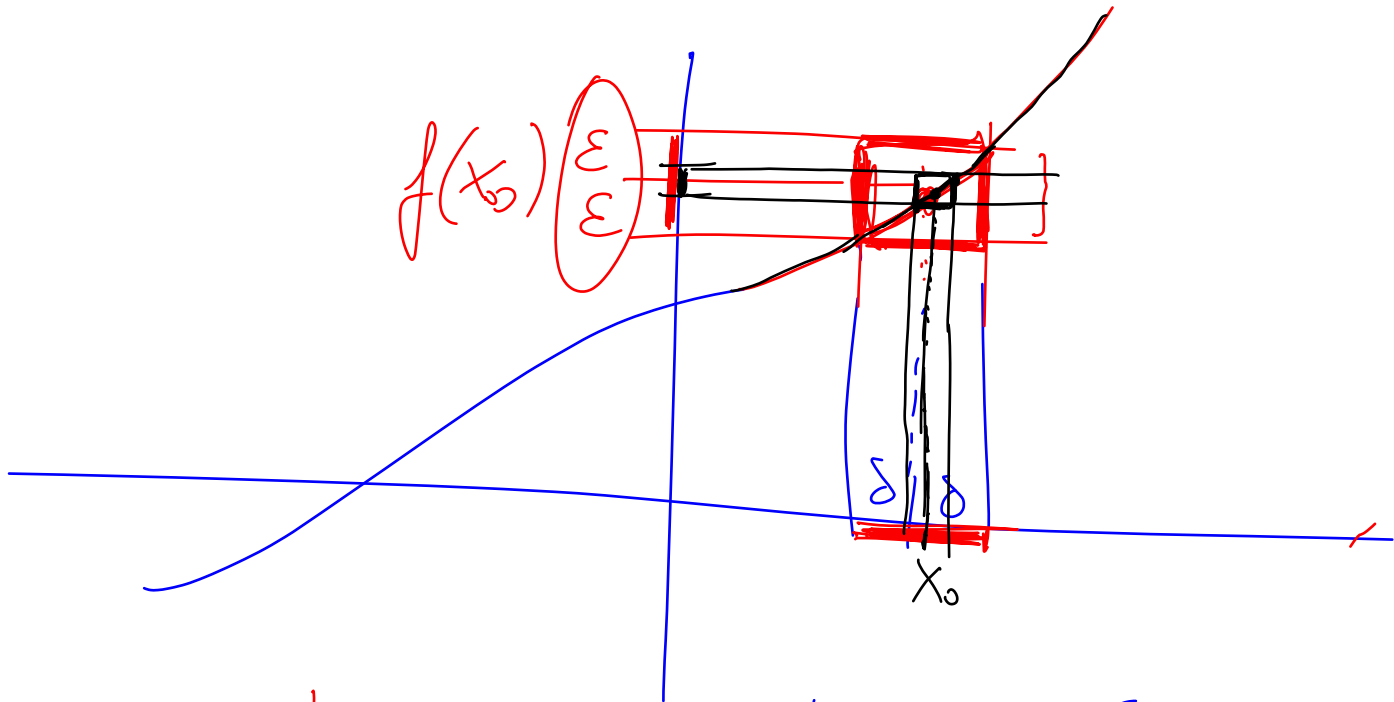

$$|x - x_0| < \delta$$

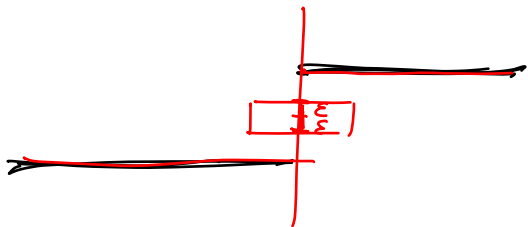

$$\lim_{x \rightarrow 3} x^2 = 9$$

$$y = f(x) = x^2$$

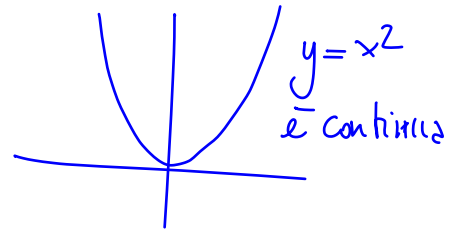

$$\lim_{x \rightarrow x_0} f(x) = f(x_0) \quad \text{se la funzione è continua}$$

$$\lim_{x \rightarrow \infty} f(x) = l \quad \text{vuol dire che}$$

$$\forall \varepsilon > 0 \quad \exists M \quad / \quad \forall x > M \quad |f(x) - l| < \varepsilon$$

$$\lim_{x \rightarrow -\infty} f(x) = l \quad \text{vuol dire che}$$

$$\forall \varepsilon > 0 \quad \exists M \quad / \quad \forall x < M \quad |f(x) - l| < \varepsilon$$

$(M < 0)$

$$\lim_{x \rightarrow \infty} \frac{x-1}{x+1} = 1$$

$$\forall \varepsilon \exists ? M \mid \forall x > M \quad \left| \frac{x-1}{x+1} - 1 \right| < \varepsilon \quad ?$$

$$\begin{aligned} \frac{x-1}{x+1} - 1 &= \frac{x-1}{x+1} - \frac{x+1}{x+1} = \frac{x-1 - (x+1)}{x+1} = \\ &= \frac{\cancel{x-1} - \cancel{x-1}}{x+1} = \frac{-2}{x+1} \end{aligned}$$

x grande (in particolare $\varepsilon > 0$)

$$\left| \frac{-2}{x+1} \right| = \frac{2}{x+1} < \varepsilon$$

moltiplico per $x+1$
e divido per ε

$$\frac{2}{\varepsilon} < x+1$$

Solteggio 1 : $\frac{2}{\varepsilon} - 1 < x$

$$x > \underbrace{\frac{2}{\varepsilon} - 1}_M$$

Scelgo $M = \frac{2}{\varepsilon} - 1$

è quindi vero che $\forall \varepsilon > 0 \exists M (= \frac{2}{\varepsilon} - 1)$

$$| \forall x > M \quad | f(x) - 1 | < \varepsilon$$

Non è detto che il limite esista

$$\lim_{x \rightarrow +\infty} \frac{1}{x} = 0$$

$$\lim_{x \rightarrow \infty} \sin(x) = \text{NON esiste}$$

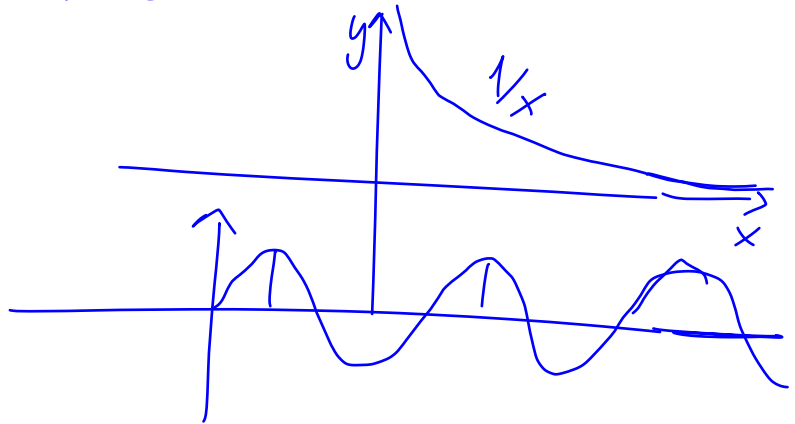

$$\lim_{x \rightarrow \infty} \frac{3x+2}{2x+1} = \lim_{x \rightarrow \infty} \frac{\cancel{3x}}{\cancel{2x}} = \frac{3}{2}$$

divido sopra e sotto per x $\frac{1}{x} (3x+2)$

$$\lim_{x \rightarrow \infty} \frac{\frac{3x+2}{x}}{\frac{2x+1}{x}} = \lim_{x \rightarrow \infty} \frac{3 + \frac{2}{x}}{2 + \frac{1}{x}} = \frac{3}{2}$$

piccolissimi
per x grande

$$\lim_{x \rightarrow \infty} \frac{7x^2 + 8x + 2}{3x^2 + 4x + 1} = \frac{7}{3}$$

divido sopra
e sotto per x^2

$$\lim_{x \rightarrow \infty} \frac{7 + \frac{8}{x} + \frac{2}{x^2}}{3 + \frac{4}{x} + \frac{1}{x^2}} = \frac{7}{3} \quad \frac{\cancel{8}}{\cancel{x}}$$

$$\lim_{x \rightarrow \infty} \frac{3x + 8x^3 + 1}{7x^2 + 3 + 5x + 11x^3} = \frac{8}{11}$$

$$\lim_{x \rightarrow \infty} \frac{3x + 1}{2x + 6x^2} = \lim_{x \rightarrow \infty} \frac{\frac{3}{x} + \frac{1}{x^2}}{\left(\frac{2}{x}\right) + 6}$$

divido per x^2

"è trascurabile rispetto a 6
nel limite $x \rightarrow \infty$ "

$$= \lim_{x \rightarrow \infty} \frac{\frac{3}{x} + \frac{1}{x^2}}{6} = \lim_{x \rightarrow \infty} \left(\frac{1}{2x} + \frac{1}{6x^2} \right) = 0$$

$$\lim_{x \rightarrow \infty} \frac{7x^4}{2x^3} = \lim_{x \rightarrow \infty} \frac{7x}{2} = \infty$$

Proprietà

$$\lim_{x \rightarrow x_0} (f(x) + g(x)) = \lim_{x \rightarrow x_0} f(x) + \lim_{x \rightarrow x_0} g(x)$$

Se esistono entrambi e sono $\neq \pm \infty$

$$\lim_{x \rightarrow \infty} 3x = \infty$$

$$\lim_{x \rightarrow \infty} (-2x) = -\infty$$

$$\lim_{x \rightarrow \infty} (3x - 2x) \stackrel{?}{=} \infty - \infty \quad \text{non ha senso}$$

$$\lim_{x \rightarrow \infty} x = \infty$$

$$\begin{aligned} \lim_{x \rightarrow \infty} (e^x - 2x) &= 0 \\ &= \infty - \infty \end{aligned}$$

$$\lim_{x \rightarrow \infty} (x+1 - x) = 1 \neq \lim_{x \rightarrow \infty} (x+1) - \lim_{x \rightarrow \infty} x$$

$$= \infty - \infty$$

$$\lim_{x \rightarrow x_0} f(x) \cdot g(x) = \lim_{x \rightarrow x_0} f(x) \cdot \lim_{x \rightarrow x_0} g(x)$$

se esistono entrambi \nearrow e sono finiti
 ("non $\pm\infty$ ")

$\infty \cdot 0$ non ha senso

$$\lim_{x \rightarrow \infty} 2x \cdot \frac{1}{x} = 2 \stackrel{?}{=} \lim_{x \rightarrow \infty} 2x \cdot \lim_{x \rightarrow \infty} \frac{1}{x} \stackrel{?}{=}$$

$$= \infty \cdot 0$$

$$\lim_{x \rightarrow x_0} \frac{f(x)}{g(x)} = \frac{\lim_{x \rightarrow x_0} f(x)}{\lim_{x \rightarrow x_0} g(x)} \quad \text{se esistono}$$

entrambi e $\lim_{x \rightarrow x_0} g(x) \neq 0, \neq \pm\infty$

Insieme: se f(x) tutto liscio (cioè non viene $\infty - \infty, \frac{\text{numero}}{0}, \frac{\infty}{0}, \infty \cdot 0, \frac{\infty}{\infty}$) allora

posso sommare, moltiplicare e dividere i limiti di f e g, per trovare i limiti di $f+g, f \cdot g, \frac{f}{g}$

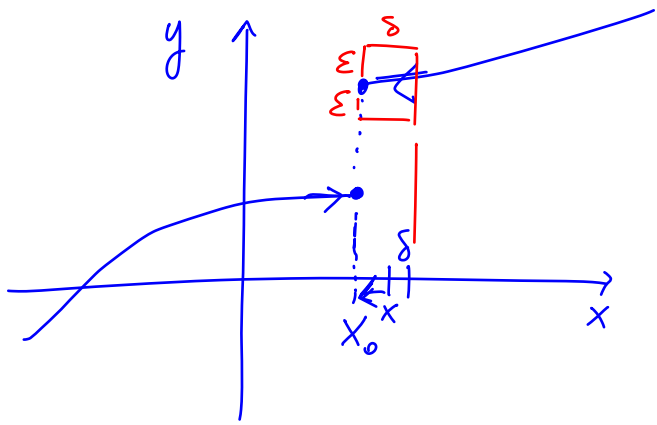

$$\nexists \lim_{x \rightarrow x_0} f(x)$$

ma possono esistere
i limiti destro e sinistro
che misurano la discontinuità

Limite destro

$$\lim_{x \rightarrow x_0^+} f(x) = l^+ \text{ se}$$

$$x \rightarrow x_0^+$$

$$\forall \epsilon > 0 \exists \delta_0 / \forall x \text{ con } 0 < x - x_0 < \delta$$

intorno destro di x_0

$$x > x_0$$

$$\text{vale } |f(x) - l^+| < \epsilon$$

Limite sinistro :

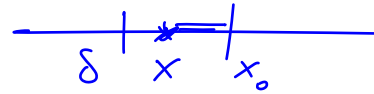

$$\lim_{x \rightarrow x_0^-} f(x) = l^- \quad \text{se}$$

$$\forall \varepsilon > 0 \exists \delta > 0 \quad / \quad \forall x \quad 0 < x_0 - x < \delta \quad |f(x) - l^-| < \varepsilon$$

Il salto di una funzione discontinua in x_0 è

la differenza $l^+ - l^-$

Se l^+ e l^- esistono e $l^+ = l^-$, allora

$\exists \lim_{x \rightarrow x_0} f(x)$ ed è uguale a $l^+ = l^-$

La funzione è continua in x_0 se $l^+ = l^- = f(x_0)$

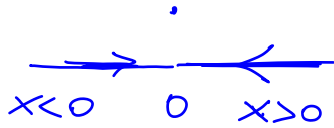

$$f(x) = \begin{cases} 0 & \text{per } x > 0 \\ 1 & \text{per } x = 0 \\ 0 & \text{per } x < 0 \end{cases}$$

$$\exists \lim_{x \rightarrow 0^+} f(x) = 0 = l^+$$

$$\exists \lim_{x \rightarrow 0^-} f(x) = 0 = l^-$$

$$\exists \lim_{x \rightarrow 0} f(x) = 0 = l^+ = l^-$$

Tuttavia, questa $f(x)$ NON è continua

in $x=0$, perché $f(0) = 1 \neq l^+, l^-$

$$\lim_{x \rightarrow \infty} \frac{\sin x}{x} \stackrel{?}{=} \frac{\lim_{x \rightarrow \infty} \sin x}{\lim_{x \rightarrow \infty} x} \quad ?$$

$$\lim_{x \rightarrow \infty} \frac{1}{x} = 0$$

$$\lim_{x \rightarrow \infty} \frac{3}{x} = 0$$

$$\lim_{x \rightarrow \infty} \left(-\frac{4}{x}\right) = 0 = \lim_{x \rightarrow \infty} (-4) \cdot \lim_{x \rightarrow \infty} \frac{1}{x}$$

$$\lim_{x \rightarrow \infty} \frac{\sin x}{x} = 0$$

$$-1 < \sin x < 1$$

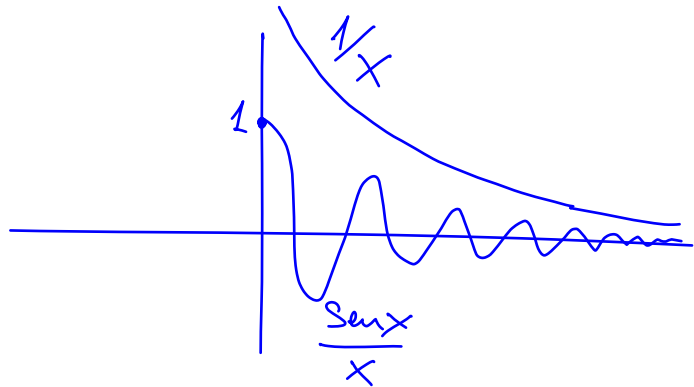

$$\lim_{x \rightarrow 0} \frac{\text{sen } x}{x} \stackrel{?}{=} \frac{\lim_{x \rightarrow 0} \text{sen } x}{\lim_{x \rightarrow 0} x} = \frac{0}{0}$$

$$\lim_{x \rightarrow 0} \frac{\text{sen } x}{x} = 1$$

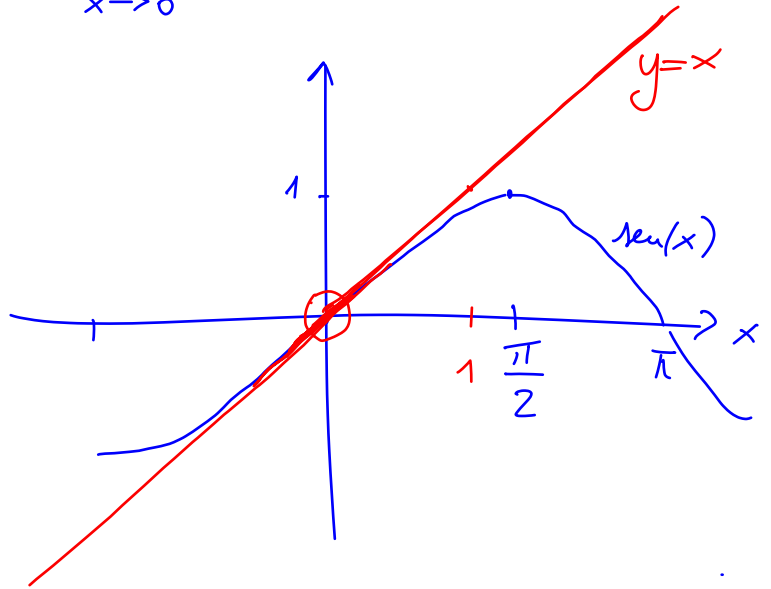

Teorema del confronto (o dei carabinieri)

$$\text{Se } f(x) \leq g(x) \leq h(x) \quad \forall x \in D$$

$$\text{e } \lim_{x \rightarrow x_0} f(x) = \lim_{x \rightarrow x_0} h(x) = l \quad x_0 \in D$$

allora \exists anche $\lim_{x \rightarrow x_0} g(x)$ ed ϵ uguale a l

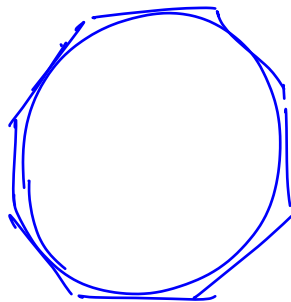
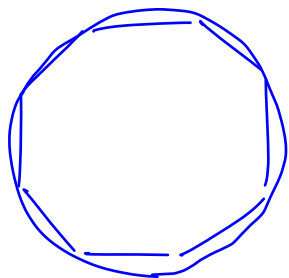

$$\text{circonferenza} = 2\pi R$$

$$\lim_{x \rightarrow 0} \frac{\sin x}{x} = 1$$

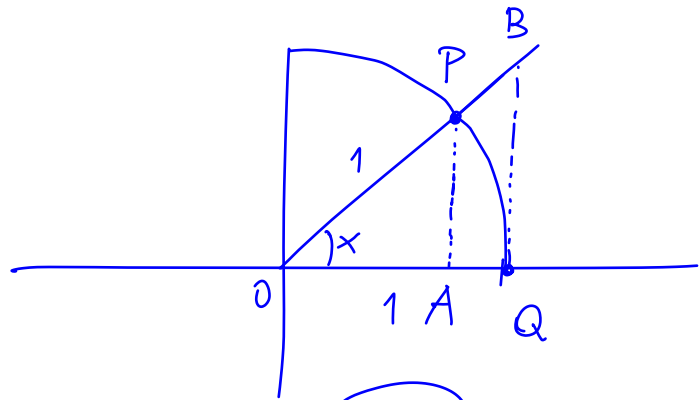

area
Triangolo $\triangle OAP$ \leq area di \widehat{OQP}

\leq area \widehat{OQB}

Esercizi:

$$\lim_{x \rightarrow 0} \frac{x}{\sin x} = \lim_{x \rightarrow 0} \frac{1}{\frac{\sin x}{x}} =$$

$$= \frac{\lim_{x \rightarrow 0} 1}{\lim_{x \rightarrow 0} \frac{\sin x}{x}} = \frac{1}{1} = 1$$

$$\lim_{x \rightarrow 0} \frac{\tan(x)}{x} = \lim_{x \rightarrow 0} \frac{\sin x}{\cos x} \cdot \frac{1}{x} =$$

$$= \lim_{x \rightarrow 0} \frac{\sin x}{x} \cdot \frac{1}{\cos x} = \lim_{x \rightarrow 0} \frac{\sin x}{x} \cdot \lim_{x \rightarrow 0} \frac{1}{\cos x} =$$

$$= 1 \cdot 1 = 1$$

$$= \sin(x) \cdot \sin(x) = (\sin(x))^2$$

$$\lim_{x \rightarrow 0} \frac{\sin^2(x)}{x^2} = \lim_{x \rightarrow 0} \frac{\sin x}{x} \cdot \frac{\sin x}{x} = 1$$

$$\lim_{x \rightarrow 0} \frac{\sin^2(x)}{x} = \lim_{x \rightarrow 0} \left(\frac{\sin x}{x} \right) \cdot (\sin x) = 1 \cdot 0 = 0$$

$$\begin{aligned}\lim_{x \rightarrow 0} \frac{1 - \cos(x)}{x^2} &= \lim_{x \rightarrow 0} \frac{1 - \cos(x)}{x^2} \frac{1 + \cos(x)}{1 + \cos(x)} = \lim_{x \rightarrow 0} \frac{\sin^2(x)}{x^2} \cdot \frac{1}{1 + \cos(x)} = \\ &= \lim_{x \rightarrow 0} \frac{\sin^2 x}{x^2} \cdot \lim_{x \rightarrow 0} \frac{1}{1 + \cos(x)} = 1 \cdot \frac{1}{2} = \frac{1}{2}\end{aligned}$$

$$\sin^2(x) + \cos^2(x) = 1$$

$$\sin^2(x) = 1 - \cos^2(x) = (1 - \cos(x)) \cdot (1 + \cos(x))$$

$$(a + b) \cdot (a - b) = a^2 - b^2$$

||

$$a \cdot (a - b) + b \cdot (a - b) =$$

$$= a^2 - \cancel{ab} + \cancel{ba} - b^2 = a^2 - b^2$$

$$\lim_{x \rightarrow 0} \frac{\sin(x) - x}{x} = \lim_{x \rightarrow 0} \left(\frac{\sin(x)}{x} - \frac{x}{x} \right) = 1 - 1 = 0$$

$$\lim_{x \rightarrow \infty} \left(\sqrt{x+1} - \sqrt{x} \right) \neq \lim_{x \rightarrow \infty} \sqrt{x+1} - \lim_{x \rightarrow \infty} \sqrt{x} = \infty - \infty$$

$$\sqrt{\underset{\text{"}x\text{"}}{100}} = 10 \quad \sqrt{10000} = 100 \quad \sqrt{1000000} = 1000$$
$$\sqrt{a \cdot 100} = \sqrt{a} \cdot 10$$

$$\lim_{x \rightarrow \infty} \sqrt{x} = \infty$$

$$\lim_{x \rightarrow \infty} \left(\sqrt{x+1} - \sqrt{x} \right) \cdot \frac{\sqrt{x+1} + \sqrt{x}}{\sqrt{x+1} + \sqrt{x}} =$$

$a - b$

$$(a - b)(a + b) = a^2 - b^2$$

$$a = \sqrt{x+1} \quad b = \sqrt{x}$$

$$= \lim_{x \rightarrow \infty} \frac{(\cancel{x+1}) - \cancel{x}}{\sqrt{x+1} + \sqrt{x}} =$$

$$= \lim_{x \rightarrow \infty} \frac{1}{\sqrt{x+1} + \sqrt{x}} = 0$$

$$\lim_{x \rightarrow \infty} \left(\frac{x^2 - 1}{x + 2} - x \right) = \lim_{x \rightarrow \infty} \frac{x^2 - 1 - x(x + 2)}{x + 2} =$$

$\infty - \infty$

$$= \lim_{x \rightarrow \infty} \frac{\cancel{x^2} - 1 - \cancel{x^2} - 2x}{x + 2} = -2$$

Limite della composizione di due funzioni

$$\text{Se } \lim_{x \rightarrow x_0} g(x) = y_0 \quad \text{e}$$

$f(y)$ è una funzione continua in y_0 , allora

$$\lim_{x \rightarrow x_0} f(g(x)) = f(y_0)$$

Possiamo fare i cambi di variabili dentro i limiti
usando funzioni continue

$$y = x^2$$

$$\text{Es.: } \lim_{x \rightarrow 0} \frac{\text{sen}(x^2)}{x^2} = \lim_{y \rightarrow 0} \frac{\text{sen}(y)}{y} = 1$$

$$\lim_{x \rightarrow 1} \frac{\sin(x-1)}{x-1} = \lim_{y \rightarrow 0} \frac{\sin(y)}{y} = 1$$

$$y = x - 1$$

$$\lim_{x \rightarrow 0} \frac{\sin(2x)}{2x} \cdot 2 = \lim_{y \rightarrow 0} \frac{\sin(y)}{y} \cdot 2 = 2$$

$$y = 2x$$

Limite notevole :

$$\lim_{x \rightarrow 0} \frac{e^x - 1}{x} = 1$$

$\searrow \frac{0}{0}$

$$\lim_{x \rightarrow 0} e^x = 1$$

$$\lim_{x \rightarrow 0} \frac{\ln(1+x)}{x} = 1$$

$$1 + \underline{x} = e^y$$

Prendo il logaritmo naturale
di entrambi

$$\ln(1+x) = \ln e^y = y$$

$$y = \ln(1+x)$$

$$\lim_{x \rightarrow 0} \frac{\ln(1+x)}{x} = \lim_{y \rightarrow 0} \frac{y}{e^y - 1} = 1$$

$$\lim_{x \rightarrow \infty} \frac{e^x}{x^n} = \infty$$

$$\forall n = 1, 2, 3, \dots$$

$$\lim_{x \rightarrow \infty} e^x = \infty$$

$$e = 2.718 \dots$$

$$a^x \quad a < 1$$

$$a^x \quad a > 1$$

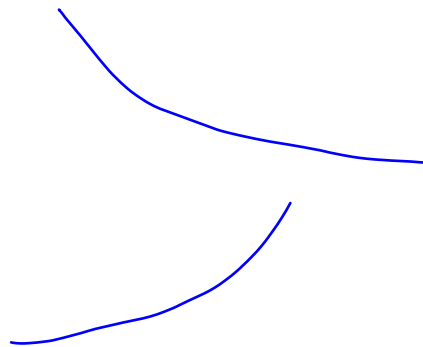

$$\lim_{x \rightarrow \infty} x = \infty$$

$$\lim_{x \rightarrow \infty} x^2 = \infty \quad \lim_{x \rightarrow \infty} x^3 = \infty$$

L'esponenziale e^x va all'infinito più velocemente

di qualunque potenza

$$\lim_{x \rightarrow \infty} \frac{e^x}{x^n} = \infty$$

$$n = 1, 2, 3, \dots$$

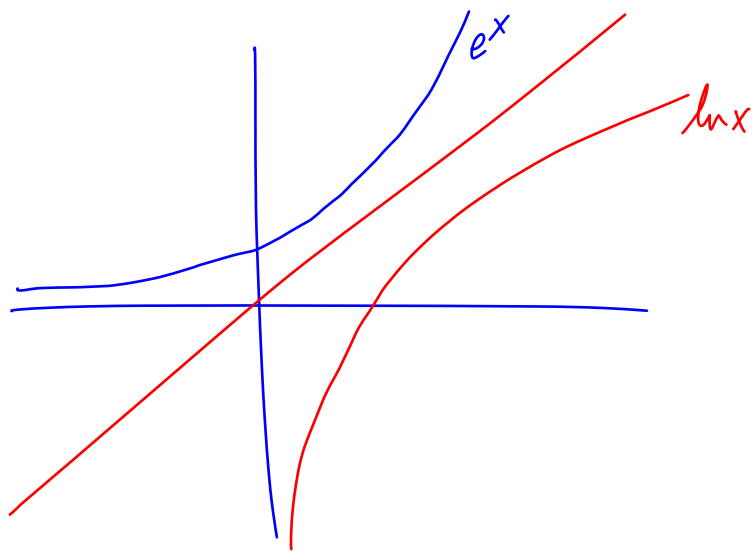

$$\lim_{x \rightarrow \infty} \ln(x) = \infty$$

Il logaritmo cresce più lentamente di qualunque potenza ($r > \text{dice}$)

$$\lim_{x \rightarrow \infty} \frac{x^{\frac{1}{n}}}{\ln x} = \infty$$

$$y = \ln x$$

$$x = e^y$$

$$= \lim_{y \rightarrow \infty} \frac{(e^y)^{\frac{1}{n}}}{y} = \infty$$

$$(a^b)^c = a^{b \cdot c}$$

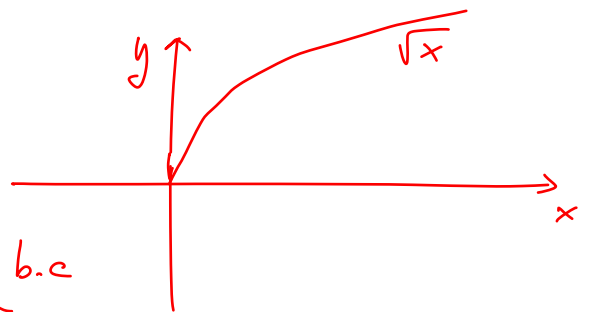

$$= \lim_{y \rightarrow \infty} \frac{e^{\frac{y}{n}}}{y} = \lim_{z \rightarrow \infty} \frac{e^z}{z \cdot n} = \infty$$

$$z = \frac{y}{n} \quad y = zn$$

$$f(x) = \frac{1}{x}$$

$$\lim_{x \rightarrow 0} \frac{1}{x}$$

non esiste

$$\lim_{x \rightarrow 0^+} \frac{1}{x} = \infty$$

$$\lim_{x \rightarrow 0^-} \frac{1}{x} = -\infty$$

x	$\frac{1}{x}$	x	$\frac{1}{x}$
$1/10$	10	$-1/10$	-10
$1/100$	100	$-1/100$	-100
$1/1000$	1000	$-1/1000$	-1000
\vdots		$1/1000$	-1000

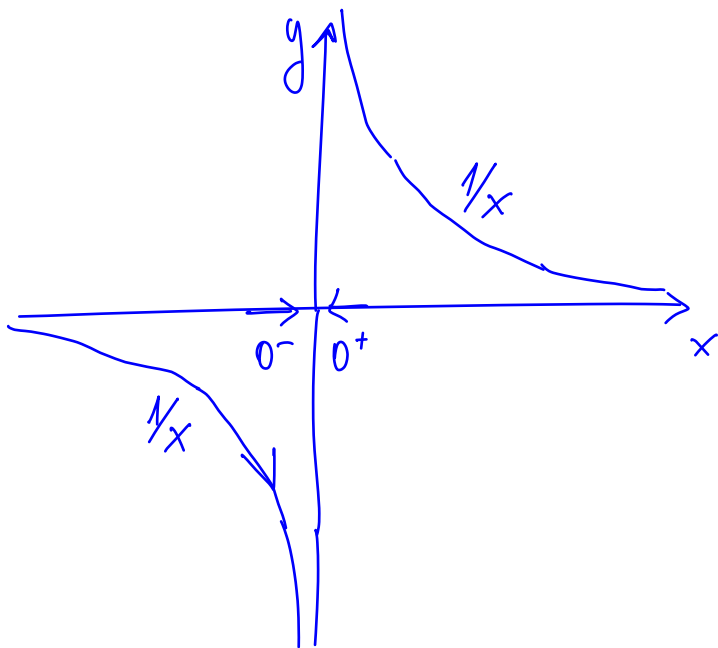

Diciamo che la funzione $f(x)$ è infinitesima
per $x \rightarrow x_0$ se $\lim_{x \rightarrow x_0} f(x) = 0$

$$\text{Se } \lim_{x \rightarrow x_0} f(x) = 0 \quad \text{e} \quad \lim_{x \rightarrow x_0} g(x) = 0$$

$$\text{e } \lim_{x \rightarrow x_0} \frac{f(x)}{g(x)} = 0, \quad \text{si dice che } f$$

è un infinitesimo di ordine superiore a g

$$\text{Es.: } f(x) = x^2 \quad x_0 = 0 \quad \lim_{x \rightarrow 0} x^2 = 0$$

$$g(x) = x \quad \lim_{x \rightarrow 0} x = 0$$

$$\lim_{x \rightarrow 0} \frac{f(x)}{g(x)} = \lim_{x \rightarrow 0} \frac{x^{\cancel{2}}}{x^{\cancel{1}}} = \lim_{x \rightarrow 0} x = 0$$

Se $f(x)$ è continua in x_0 allora vale

$$\lim_{x \rightarrow x_0} f(x) = f(x_0)$$

$$\lim_{x \rightarrow x_0} (f(x) - f(x_0)) = 0$$

$$\lim_{x \rightarrow x_0} f(x_0)$$

$g(x) = f(x) - f(x_0)$ è
infinitesima per $x \rightarrow x_0$

$$f(x) = x^2 \quad x_0 = 2$$
$$f(x_0) = 4$$

$$h(x) = x - x_0 \quad \lim_{x \rightarrow x_0} h(x) = 0$$

h è infinitesima per $x \rightarrow x_0$

Considero $\lim_{x \rightarrow x_0} \frac{f(x) - f(x_0)}{x - x_0} =$ (se esiste) derivata della funzione $f(x)$ in x_0

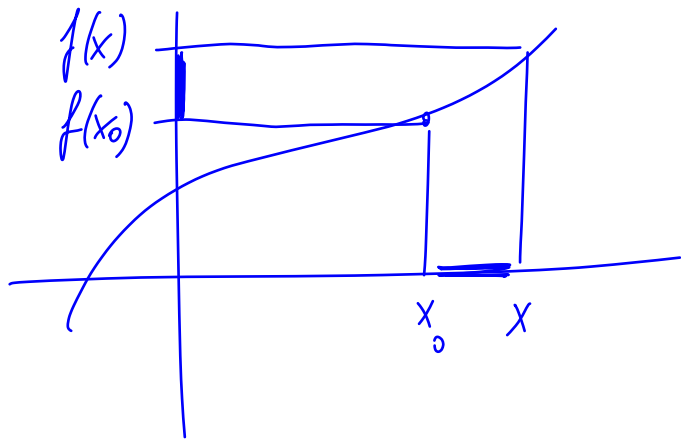

Se esiste la funzione si dice derivabile

$\frac{f(x) - f(x_0)}{x - x_0}$ si chiama rapporto incrementale

Es.: Se x è il tempo e $f(x)$ è la distanza percorsa

Esempio $y = f(x) = \text{retta} = mx + q$ m, q
costanti date

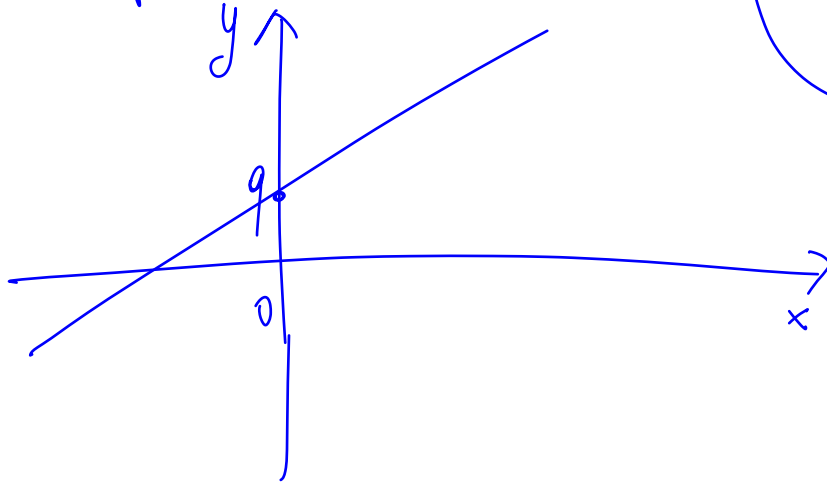

↳ termine noto
↳ coefficiente angolare

derivata di $f(x)$ in x_0 :

$$\lim_{x \rightarrow x_0} \frac{f(x) - f(x_0)}{x - x_0} = \lim_{x \rightarrow x_0} \frac{mx + q - (mx_0 + q)}{x - x_0} =$$

$$= \lim_{x \rightarrow x_0} \frac{m \cancel{x} + q - m \cancel{x_0} - q}{x - x_0} =$$

$$= \lim_{x \rightarrow x_0} \frac{m \cdot \cancel{(x - x_0)}}{\cancel{(x - x_0)}} = m \quad \text{pendenza della retta}$$

$$y = 3$$

$$m = 0$$

$$q = 3$$

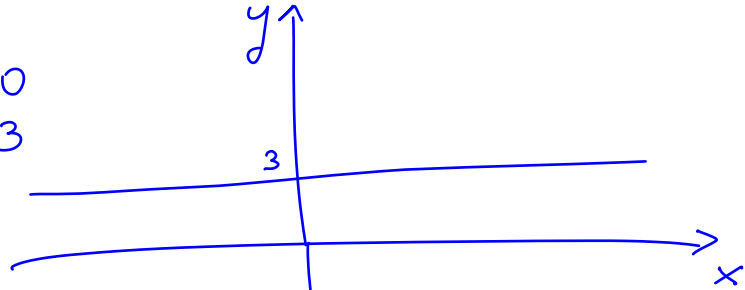

la derivata di una costante è zero

$$y = x$$

$$m = 1$$

$$q = 0$$

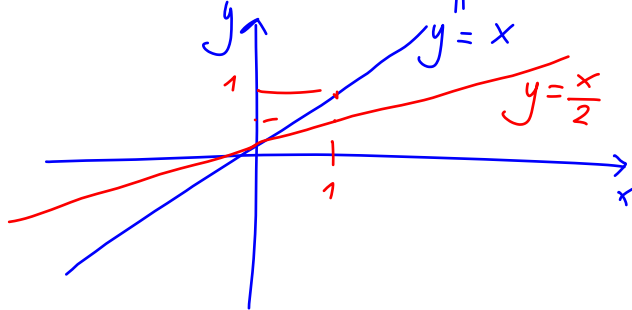

$$y = \frac{x}{2} \quad m = \frac{1}{2}$$

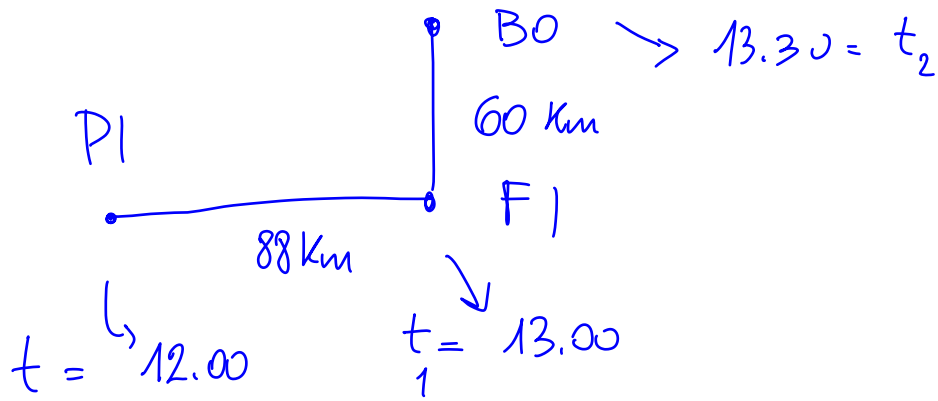

$$\frac{\text{distansza (P1-B0)} - \text{dist (P1-F1)}}{t (\text{P1-B0}) - t (\text{P1-F1})} = \frac{60 \text{ km}}{30 \text{ min}}$$

vitezita
 medie

derivata: vitezita instantanea

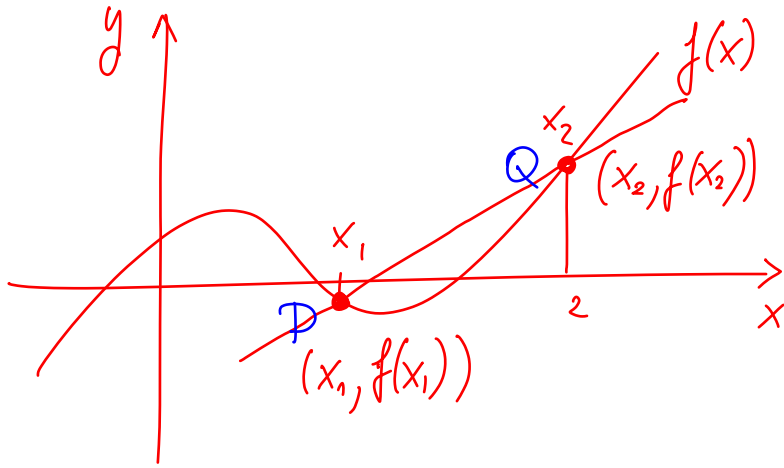

Considero

$$m = \frac{f(x_2) - f(x_1)}{x_2 - x_1}$$

$$q = f(x_1) - mx_1$$

$$y = mx + q \quad \text{è una retta}$$

Dobbiamo far vedere che passa per P e Q, cioè

$$f(x_1) = mx_1 + q \quad f(x_2) = mx_2 + q$$

$$\begin{aligned} mx_2 + q &= mx_2 + f(x_1) - mx_1 = f(x_1) + m(x_2 - x_1) = \\ &= \cancel{f(x_1)} + f(x_2) - \cancel{f(x_1)} = f(x_2) \end{aligned}$$

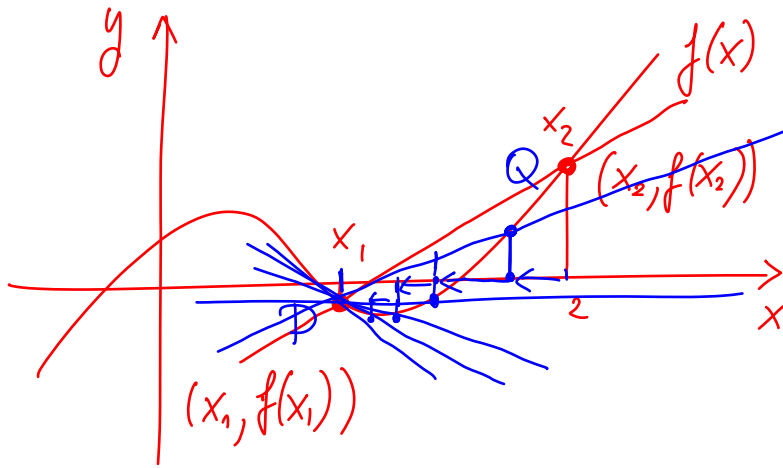

$$m = \frac{f(x_2) - f(x_1)}{x_2 - x_1}$$

Tengo fisso x_1
e muovo x_2 verso x_1

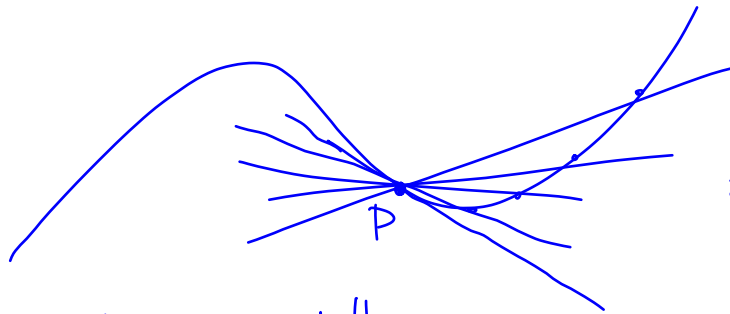

La pendenza m della
retta tangente è la derivata

al limite $x_2 \rightarrow x_1$
otengo una retta che
nei dintorni di x_1 ha
uno e un solo punto (P)
di intersezione col grafico di f

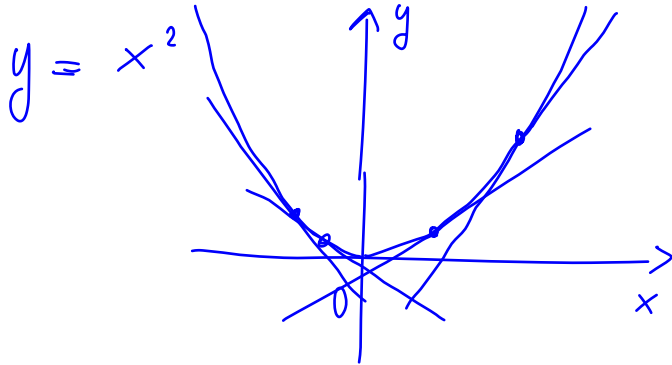

$$f(x) = x^2$$

$$x - x_0 = \delta$$

$$\lim_{x \rightarrow x_0} \frac{f(x) - f(x_0)}{x - x_0} = \lim_{\delta \rightarrow 0} \frac{f(x_0 + \delta) - f(x_0)}{\delta}$$

rimuovo x_0 come x

$$f'(x) = \lim_{\delta \rightarrow 0} \frac{f(x + \delta) - f(x)}{\delta} = \frac{df}{dx}(x)$$

notazione
di Leibniz



"de f su
de"

$$y = x^2 = f(x) \quad f(x+\delta) \quad f(x)$$

$$f'(x) = \lim_{\delta \rightarrow 0} \frac{(x+\delta)^2 - x^2}{\delta} = \lim_{x \rightarrow 0} \frac{\cancel{x^2} + 2x\delta + \delta^2 - \cancel{x^2}}{\delta}$$

$$\begin{aligned} (x+\delta)^2 &= (x+\delta)(x+\delta) = x \cdot (x+\delta) + \delta \cdot (x+\delta) = \\ &= x^2 + x\delta + \delta x + \delta^2 = x^2 + 2x\delta + \delta^2 \end{aligned}$$

$$= \lim_{\delta \rightarrow 0} \frac{\cancel{\delta} \cdot (2x + \delta)}{\cancel{\delta}} = 2x$$

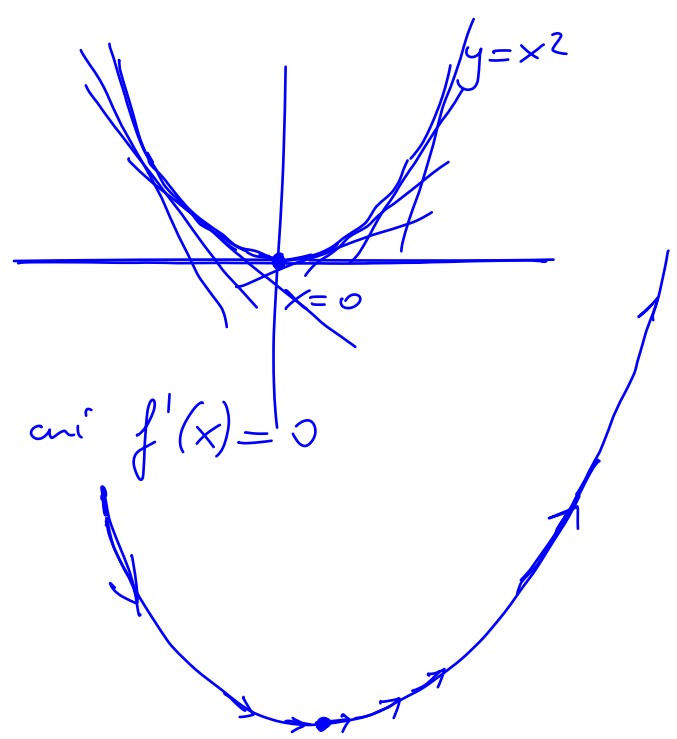
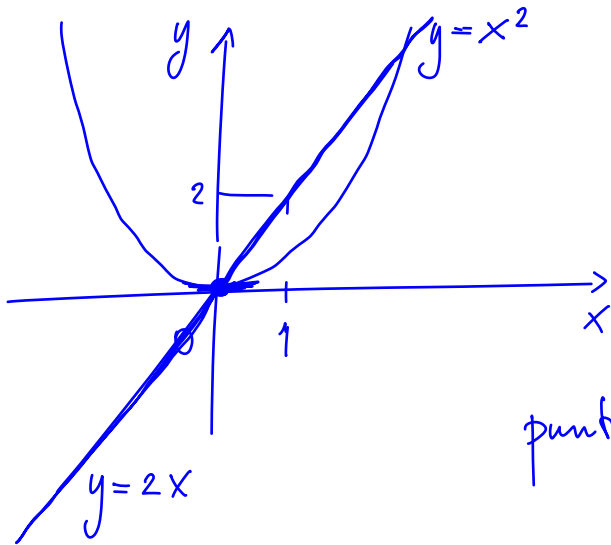

punti in cui $f'(x) = 0$

$$y = f(x) = \sin(x)$$

$$f'(x) = \lim_{\delta \rightarrow 0} \frac{f(x+\delta) - f(x)}{\delta} = \lim_{\delta \rightarrow 0} \frac{\sin(x+\delta) - \sin(x)}{\delta}$$

$$\sin(\alpha + \beta) = \sin(\alpha) \cdot \cos(\beta) + \sin(\beta) \cos(\alpha)$$

$$= \lim_{\delta \rightarrow 0} \frac{\sin(x) \cdot \cos(\delta) + \overbrace{\cos(x) \cdot \sin(\delta)} - \sin(x)}{\delta} =$$

$$= \lim_{\delta \rightarrow 0} \cos(x) \frac{\sin(\delta)}{\delta} + \lim_{\delta \rightarrow 0} \sin(x) \frac{\cos(\delta) - 1}{\delta}$$

$$= \cos(x) - \sin(x) \lim_{\delta \rightarrow 0} \frac{1 - \cos(\delta)}{\delta} = \cos(x)$$

$$\lim_{\delta \rightarrow 0} \frac{1 - \cos(\delta)}{\delta^2} = \frac{1}{2} \quad \nabla$$

$$\lim_{\delta \rightarrow 0} \frac{1 - \cos(\delta)}{\delta} = \lim_{\delta \rightarrow 0} \frac{1 - \cos(\delta)}{\delta} \cdot \frac{\delta}{\delta} = \lim_{\delta \rightarrow 0} \frac{1 - \cos(\delta)}{\delta^2} \delta = 0$$

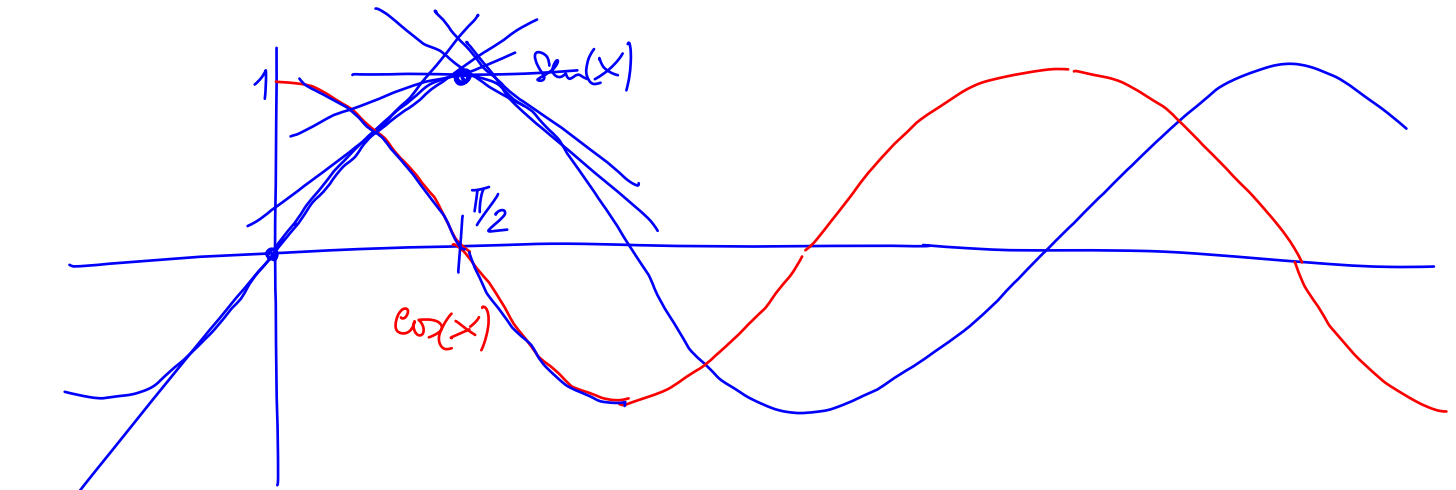

$$f(x) = \cos(x) \quad f'(x) = -\text{sen}(x)$$

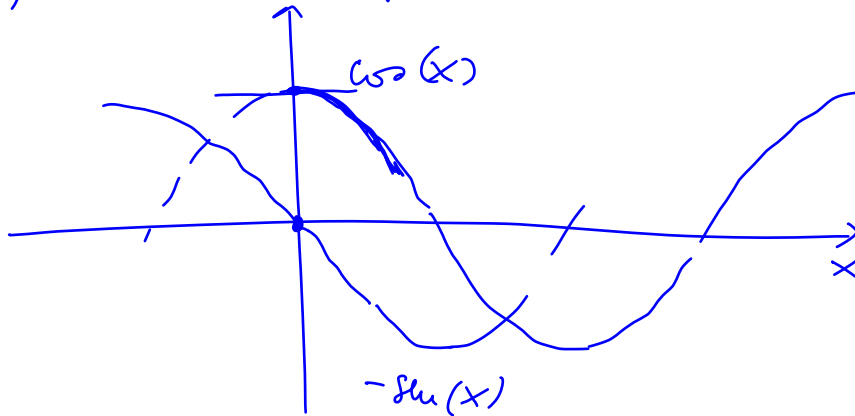

$$f(x) = \ln x \quad x > 0 \quad \ln(a \cdot b) = \ln a + \ln b$$

$$f'(x) = \lim_{\delta \rightarrow 0} \frac{\ln(x+\delta) - \ln x}{\delta} = \boxed{\lim_{u \rightarrow 0} \frac{\ln(1+u)}{u} = 1}$$
$$= \lim_{\delta \rightarrow 0} \frac{\ln \left[x \cdot \left(1 + \frac{\delta}{x} \right) \right] - \ln(x)}{\delta} =$$

$$= \lim_{\delta \rightarrow 0} \frac{\cancel{\ln(x)} + \ln \left(1 + \frac{\delta}{x} \right) - \cancel{\ln(x)}}{\delta} =$$

$$= \lim_{\delta \rightarrow 0} \frac{\ln \left(1 + \frac{\delta}{x} \right)}{\frac{\delta}{x} \cdot x} = \lim_{u \rightarrow 0} \frac{\ln(1+u)}{u} \cdot \frac{1}{x} = \frac{1}{x}$$

$$u = \frac{\delta}{x}$$

$$f(x) = e^x$$

$$f'(x) = \underline{\underline{e^x}}$$

$$e^{a+b} = e^a \cdot e^b$$

$$\lim_{\delta \rightarrow 0} \frac{f(x+\delta) - f(x)}{\delta} = \lim_{\delta \rightarrow 0} \frac{e^{x+\delta} - e^x}{\delta} =$$

$$= \lim_{\delta \rightarrow 0} \frac{e^x \cdot e^\delta - e^x}{\delta} =$$

$$= \lim_{\delta \rightarrow 0} \underbrace{e^x}_{\text{factor out}} \cdot \frac{e^\delta - 1}{\delta} = \underline{\underline{e^x}}$$

$$\lim_{x \rightarrow 0} \frac{e^x - 1}{x} = 1 \quad \swarrow$$

derivata

$f(x)$

$$f'(x) = \lim_{\delta \rightarrow 0} \frac{f(x+\delta) - f(x)}{\delta}$$

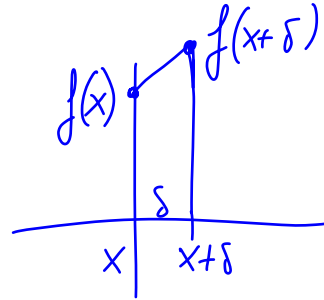
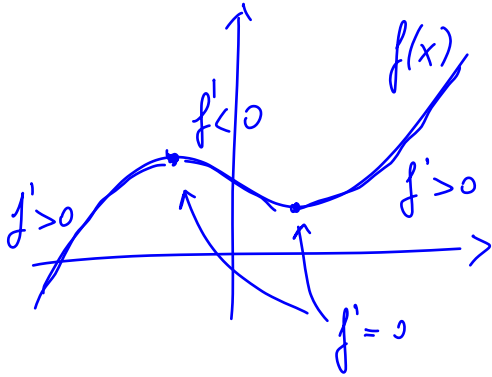

angolare
coefficiente
derivata

↓
 $y = mx + q$

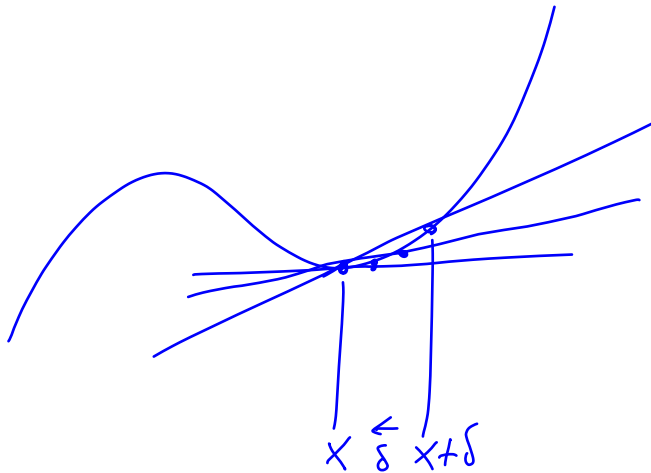

retta tangente

$f(x)$	c constante	x	Cx	x^2	$\text{sen}(x)$	$\text{cos}(x)$
$f'(x)$	0	1	C	$2x$	$\text{cos}(x)$	$-\text{sen}(x)$

$f(x)$	$\ln x$ $x > 0$	e^x	x^n
$f'(x)$	$\frac{1}{x}$	e^x	$n x^{n-1}$

La derivata di una somma $f(x) + g(x)$ di funzioni
è la somma $f'(x) + g'(x)$ delle derivate

$$\lim_{\delta \rightarrow 0} \frac{f(x+\delta) + g(x+\delta) - f(x) - g(x)}{\delta} =$$

$$= \lim_{\delta \rightarrow 0} \left(\frac{f(x+\delta) - f(x)}{\delta} + \frac{g(x+\delta) - g(x)}{\delta} \right) =$$

$$= \lim_{\delta \rightarrow 0} \frac{f(x+\delta) - f(x)}{\delta} + \lim_{\delta \rightarrow 0} \frac{g(x+\delta) - g(x)}{\delta} =$$

$$= f'(x) + g'(x)$$

Regola di Leibniz

la derivata del prodotto $f(x) \cdot g(x)$ di due funzioni $f(x)$ e $g(x)$ è

$$f'(x) \cdot g(x) + f(x) \cdot g'(x)$$

$$\begin{aligned} & \lim_{\delta \rightarrow 0} \frac{f(x+\delta) \cdot g(x+\delta) - f(x) \cdot g(x)}{\delta} = \\ & = \lim_{\delta \rightarrow 0} \frac{f(x+\delta) \cdot g(x+\delta) - f(x) \cdot g(x+\delta) + f(x) \cdot g(x+\delta) - f(x) \cdot g(x)}{\delta} \\ & = \lim_{\delta \rightarrow 0} \frac{(f(x+\delta) - f(x)) \cdot g(x+\delta) + f(x) \cdot (g(x+\delta) - g(x))}{\delta} = \end{aligned}$$

$$= \lim_{\delta \rightarrow 0} \frac{f(x+\delta) - f(x)}{\delta} \cdot g(x+\delta) + \lim_{\delta \rightarrow 0} f(x) \cdot \frac{g(x+\delta) - g(x)}{\delta} =$$

$$= f'(x) \cdot g(x) + f(x) g'(x)$$

Vale :

$$\lim_{\delta \rightarrow 0} g(x+\delta) = g(x)$$

perché $g(x)$ è
continua in x

Perché? Perché stiamo assumendo che $\exists g'(x)$ e
una funzione derivabile è anche continua

Stiamo assumendo $g'(x) = \lim_{\delta \rightarrow 0} \frac{g(x+\delta) - g(x)}{\delta}$

Ma allora

$$\lim_{\delta \rightarrow 0} (g(x+\delta) - g(x)) = \lim_{\delta \rightarrow 0} \frac{g(x+\delta) - g(x)}{\delta} \cdot \delta =$$

$$= \lim_{\delta \rightarrow 0} \frac{g(x+\delta) - g(x)}{\delta} \cdot \lim_{\delta \rightarrow 0} \delta = g'(x) \cdot 0 = 0$$

Pertanto $\lim_{\delta \rightarrow 0} (g(x+\delta) - g(x)) = 0$

cioè $\lim_{\delta \rightarrow 0} g(x+\delta) = g(x)$

Esempio $f(x) = x$ $g(x) = x$

$$f(x) \cdot g(x) = x^2 = h(x)$$

$$h'(x) = 2x$$

$$f'(x) = 1$$

$$f'(x) g'(x) = 1 \quad :$$

$$g'(x) = 1$$

il prodotto delle derivate non coincide
niente con la derivata del prodotto

Leibniz: $f'(x) \cdot g(x) + f(x) \cdot g'(x) = 1 \cdot x + x \cdot 1 = 2x$

$$f(x) = x^n \quad f'(x) = nx^{n-1}$$

$$n=3 \quad f(x) = x^3 \quad f'(x) \stackrel{?}{=} 3x^2$$

$$f(x) = x^3 = x^2 \cdot x$$

$$f'(x) = 2x \cdot x + 1 \cdot x^2 = 3x^2$$

la derivata di $k f(x)$, $k = \text{costante}$, e⁻

$$k \cdot f'(x)$$

$$\lim_{\delta \rightarrow 0} \frac{k f(x+\delta) - k f(x)}{\delta} = k \lim_{\delta \rightarrow 0} \frac{f(x+\delta) - f(x)}{\delta}$$

$$f(x) = |x| = \begin{cases} x & x > 0 \\ 0 & x = 0 \\ -x & x < 0 \end{cases}$$

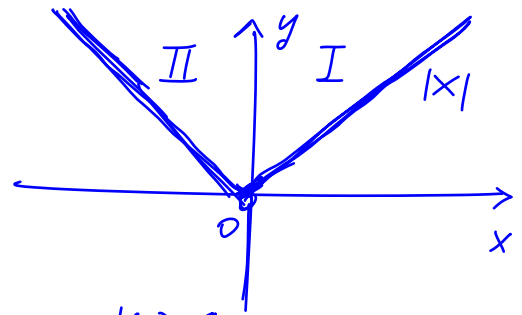

$$f'(x) = \begin{cases} 1 & x > 0 \\ -1 & x < 0 \end{cases}$$

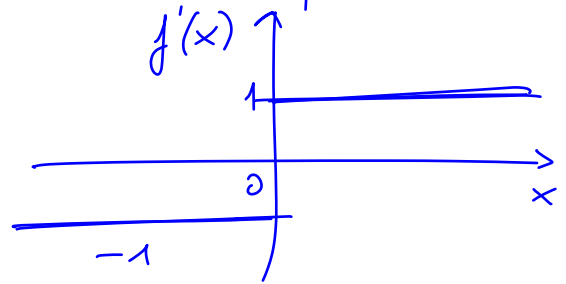

f non è derivabile per $x=0$

Derivata della funzione composta

$$h(x) = f(g(x))$$

$$h(x) = \sqrt{x+2}$$

$$f(y) = \sqrt{y}$$

$$f(g(x)) = \sqrt{x+2}$$

$$y = g(x) = x+2$$

$$h(x) = f(g(x)) \quad y = g(x)$$

$$h'(x) = f'(y) \cdot g'(x) \quad \text{dove } y = g(x)$$

$$h(x) = \sin(x^2) \quad y = x^2 \quad y'(x) =$$
$$= \sin(y(x)) \quad \sin(y)$$

$$h'(x) = \cos(y) \cdot 2x \quad \text{dove } y = x^2$$
$$= 2x \cos(x^2)$$

$$\underline{h(x)} = f(g(x)) = f(y) \quad y = g(x) = x^2 \quad f(y) = \sin(y)$$

$$h'(x) = \cos(x^2) \cdot 2x$$

$$f'(x) = \lim_{\delta \rightarrow 0} \frac{f(x+\delta) - f(x)}{\delta}$$

$$h(x) = f(g(x))$$

$$h'(x) = \lim_{\delta \rightarrow 0} \frac{h(x+\delta) - h(x)}{\delta} = \lim_{\delta \rightarrow 0} \frac{f(g(x+\delta)) - f(g(x))}{\delta}$$

$$= \lim_{\delta \rightarrow 0} \frac{f(g(x+\delta)) - f(g(x))}{g(x+\delta) - g(x)} \cdot \frac{g(x+\delta) - g(x)}{\delta} =$$

$$\stackrel{?}{=} \lim_{\delta \rightarrow 0} \frac{f(g(x+\delta)) - f(g(x))}{g(x+\delta) - g(x)} \cdot \underbrace{\lim_{\delta \rightarrow 0} \frac{g(x+\delta) - g(x)}{\delta}}_{\hookrightarrow g'(x)}$$

$$\lim_{\delta \rightarrow 0} \frac{f(g(x+\delta)) - f(g(x))}{g(x+\delta) - g(x)} = \lim_{\Delta \rightarrow 0} \frac{f(y+\Delta) - f(y)}{\Delta} = f'(y)$$

$$g(x+\delta) - g(x) = \Delta \quad y = g(x)$$

$$g(x+\delta) = g(x) + \Delta = y + \Delta$$

$$\lim_{\delta \rightarrow 0} (g(x+\delta) - g(x)) = 0 \quad \lim_{\delta \rightarrow 0} g(x+\delta) = g(x)$$

g è continua

Se $\exists g'(x)$ (g è derivabile in x)

allora g è continua in x

Quindi $h'(x) = f'(y) \cdot g'(x)$ dove $y = g(x)$

$$h(x) = e^{x^2} \quad f(y) = e^y \quad y = x^2 = g(x)$$

$$h'(x) = e^y \cdot 2x = e^{x^2} \cdot 2x$$

$$h(x) = \sin^2(x) = \sin(x) \cdot \sin(x) = f(x) \cdot g(x)$$

$$\begin{aligned} f(x) &= \sin(x) & g(x) &= \sin(x) \\ f'(x) &= \cos(x) & g'(x) &= \cos(x) \end{aligned}$$

$$h'(x) = f'(x) \cdot g(x) + f(x) \cdot g'(x) =$$

$$= \cos(x) \cdot \sin(x) + \sin(x) \cdot \cos(x) = 2\sin(x)\cos(x)$$

Come funzione composta

$$h(x) = \text{sen}^2(x)$$

$$y = g(x) = \text{sen}(x)$$

$$f(y) = y^2$$

$$f(g(x)) = (g(x))^2 = (\text{sen}(x))^2$$

$$h'(x) = f'(y) \cdot g'(x) \quad \text{dove } y = g(x)$$

$$= 2y \cdot \cos(x) \quad \text{dove } y = \text{sen}(x)$$

$$= 2 \text{sen}(x) \cdot \cos(x)$$

$f(x) = x^n$	$f'(x) = n x^{n-1}$	
$n = -1$	$f(x) = \frac{1}{x}$	$f'(x) = -\frac{1}{x^2}$

$$h(x) = \frac{1}{\text{sen}(x)}$$

$$y = g(x) = \text{sen}(x)$$

$$f(y) = \frac{1}{y}$$

$$h'(x) = f'(y) \cdot g'(x) = -\frac{1}{y^2} \cos(x) = -\frac{\cos(x)}{\text{sen}^2(x)}$$

$$h(x) = \frac{1}{g(x)} = f(g(x))$$

$$y = g(x)$$

$$f(y) = \frac{1}{y}$$

$$h'(x) = f'(y) \cdot g'(x) = -\frac{1}{y^2} g'(x) = -\frac{g'(x)}{g^2(x)}$$

Derivata di $\frac{1}{f(x)}$ è $-\frac{f'(x)}{f^2(x)}$

$$h(x) = \frac{f(x)}{g(x)} = f(x) \cdot \frac{1}{g(x)}$$

Leibniz: $h'(x) = f'(x) \cdot \frac{g(x)}{g^2(x)} + f(x) \frac{(-1) \cdot g'(x)}{g^2(x)} =$

$$= \frac{f'(x) \cdot g(x) - f(x) \cdot g'(x)}{g^2(x)}$$

$$f(x) = \sin(x)$$

$$g(x) = \cos(x)$$

$$g'(x) = -\sin(x)$$

$$h(x) = \lg(x) = \frac{\sin(x)}{\cos(x)}$$

$$h'(x) = \frac{\cos(x) \cdot \cos(x) - \sin(x) \cdot (-\sin(x))}{\cos^2(x)} =$$

$$= \frac{\cos^2(x) + \sin^2(x)}{\cos^2(x)} = \frac{1}{\cos^2(x)}$$

$\lg(x)$ non è derivabile dove $\cos(x) = 0$

$$x = \frac{\pi}{2}, \frac{3\pi}{2}, \dots$$

Derivata della funzione inversa

$$y = f(x) \quad x = f^{-1}(y)$$

$$h(x) = f(g(x)) \quad \text{Prendo } y = g(x) = f^{-1}(x)$$
$$= f(f^{-1}(x)) = x$$

$$h'(x) = 1 = f'(y) \cdot g'(x) \quad \text{dove } y = g(x) = f^{-1}(x)$$

$$g'(x) = \frac{1}{f'(y)} \quad \text{dove } y = f^{-1}(x)$$

↑
derivata f. inversa

$$f(x) = e^x \quad f^{-1}(x) = \ln x \quad (x > 0)$$
$$f'(x) = e^x \quad g(x) = \ln x \quad g'(x) = \frac{1}{x} \quad (x > 0)$$

Verifichiamo se

$$g'(x) = \frac{1}{f'(y)} \quad \text{dove } y = f^{-1}(x)$$
$$y = \ln(x) = g(x)$$

$$g'(x) = \frac{1}{e^y} \quad \text{dove } y = \ln x$$

$$= \frac{1}{e^{\ln x}} = \frac{1}{x}$$

$$\frac{0}{0} \quad \frac{\infty}{\infty} \quad \text{forme indeterminate}$$

Teorema di de l'Hospital

Se f e g sono continue in un intorno I_{x_0} di x_0
e derivabili in $I_{x_0} \setminus \{x_0\}$ e $g'(x) \neq 0$

$g'(x) \neq 0$ in $I_{x_0} \setminus \{x_0\}$

$$\text{Se } \frac{f(x)}{g(x)} = \frac{0}{0} \cdot \frac{\infty}{\infty} \quad \text{per } x \rightarrow x_0$$

$$\text{allora } \lim_{x \rightarrow x_0} \frac{f(x)}{g(x)} = \lim_{x \rightarrow x_0} \frac{f'(x)}{g'(x)}$$

$$\lim_{x \rightarrow 0} \frac{\sin(x)}{x} \text{ " } \frac{0}{0} \text{ " } = \lim_{x \rightarrow 0} \frac{\cos(x)}{1} = 1$$

$$\lim_{x \rightarrow 0} \frac{\ln(1+x)}{x} \text{ " } \frac{0}{0} \text{ " } = \lim_{x \rightarrow 0} \frac{\frac{1}{1+x}}{1} = 1$$

$$h(x) = \ln(1+x) \quad y = g(x) = 1+x \quad f(y) = \ln(y)$$

$$h'(x) = f'(y) \cdot g'(x) = \frac{1}{y} \cdot 1 = \frac{1}{1+x}$$

$$h(x) = \ln(g(x))$$

$$h'(x) = \frac{1}{g(x)} \cdot g'(x) = \frac{g'(x)}{g(x)}$$

NON applicare se non è $\frac{0}{0}$ o $\frac{\infty}{\infty}$

$$\text{Es. } \lim_{x \rightarrow 0} \frac{x}{1+x} = 0 \neq \lim_{x \rightarrow 0} \frac{1}{1} = 1$$

$$\lim_{x \rightarrow 0} \frac{e^x - 1}{x} = \lim_{x \rightarrow 0} \frac{e^x}{1} = 1$$

$\frac{0}{0} \quad e^0 = 1$

$$\lim_{x \rightarrow 0} \frac{1 - \cos(x)}{x^2} = \lim_{x \rightarrow 0} \frac{\sin(x)}{2x} = \frac{1}{2}$$

$\frac{0}{0} \quad \frac{0}{0}$

$$\lim_{x \rightarrow 0} \frac{\sin(e^x - 1)}{\sin(3x)} = \lim_{x \rightarrow 0} \frac{e^x \cdot \cos(e^x - 1)}{3 \cos(3x)} = \frac{1}{3}$$

$\frac{0}{0}$

$$f(x) = \sin(e^x - 1)$$

$$g(x) = \sin(3x)$$

$\underbrace{\quad}_{y}$

$$f(x) = \sin(\underbrace{e^x - 1}_y)$$

$$h(x) = \sin(e^{-x})$$

$$h'(x) = f'(y) \cdot g'(x)$$

$$g'(x) = \cos(3x) \cdot 3$$

$$f'(x) = \cos(e^x - 1) \cdot e^x$$

$$y = e^{-x} = g(x)$$

$$f(y) = \sin(y)$$

$$g(x) = e^{-x}$$

$$g'(x) = -e^{-x}$$

$$h(x) = \sin(e^{-x})$$

$$h'(x) = f'(y) \cdot g'(x)$$

$$y = e^{-x} = g(x)$$

$$f(y) = \sin(y)$$

$$h'(x) = \cos(y) \cdot (-1)e^{-x} = -e^{-x} \cos(e^{-x})$$

$$h(x) = e^{-x}$$

$$= f(g(x))$$

$$y = g(x) = -x$$

$$f(y) = e^y$$

$$h'(x) = f'(y) \cdot g'(x)$$

$$= e^y \cdot (-1) = -e^{-x}$$

$$\lim_{x \rightarrow 0} \frac{\sin(3x^2)}{x \ln(1+4x)} = \lim_{x \rightarrow 0} \frac{\sin(3x^2)}{3x^2} \cdot \frac{\frac{3}{4} \cdot 4x}{\ln(1+4x)} = \frac{3}{4}$$

$$\lim_{x \rightarrow 0} \frac{\sin(x)}{x} = 1$$

$$\lim_{x \rightarrow 0} \frac{\sin(3x^2)}{3x^2} = \lim_{\substack{y \rightarrow 0 \\ y=3x^2}} \frac{\sin(y)}{y} = 1$$

$$\lim_{x \rightarrow 0} \frac{\ln(1+x)}{x} = 1$$

$$\lim_{x \rightarrow 0} \frac{\frac{3}{4} \cdot 4x}{\ln(1+4x)}$$

$$\lim_{x \rightarrow 0} \frac{x}{\ln(1+x)} = 1$$

$$\lim_{x \rightarrow 0} \frac{\sin(\overbrace{2x+x^2}^y)}{3x} = \frac{0}{0}$$

$$\lim_{x \rightarrow 0} \frac{\cos(2x+x^2) \cdot (2+2x)}{3} = \frac{2}{3}$$

$$\lim_{x \rightarrow 0} \frac{\sin(3x)}{\ln(1+2x)} = \lim_{x \rightarrow 0} \frac{\sin(3x)}{3x} \cdot \frac{2x}{\ln(1+2x)} \cdot \frac{3}{2} = \frac{3}{2}$$

$$\lim_{x \rightarrow 1} \frac{\ln(x^2)}{x-1}$$

$$\lim_{x \rightarrow 1} \frac{\cos\left(\frac{\pi}{2}x\right)}{x-1}$$

$$\lim_{x \rightarrow 1} \frac{\sin(\pi x)}{\ln(x)}$$

$$\lim_{x \rightarrow 0} \frac{\sin(\pi - x^2)}{7x^2 e^x}$$

$$h(x) = \sin(\pi x) \quad y = \pi x = g(x) \quad f(y) = \sin(y)$$
$$h(x) = f(g(x))$$
$$h'(x) = f'(y) \cdot g'(x) = \cos(y) \cdot \pi = \pi \cos(\pi x)$$

$$\lim_{x \rightarrow 1} \frac{\sin(\pi x)}{\ln(x)} = \lim_{x \rightarrow 1} \frac{\pi \cos(\pi x)}{\frac{1}{x}} = \frac{-\pi}{1} = -\pi$$

$$\lim_{x \rightarrow 1} \frac{\ln(x^2)}{x-1} = \lim_{x \rightarrow 1} \frac{\frac{2}{x}}{1} = 2$$

$$h(x) = \ln(x^2) \quad y = g(x) = x^2 \quad f(y) = \ln(y)$$

$$h(x) = f(g(x)) \quad h'(x) = f'(y) \cdot g'(x) =$$

$$= \frac{1}{y} \cdot 2x = \frac{2x}{x^2} = \frac{2}{x}$$

$$h(x) = \ln(x^2) = 2 \ln(x)$$

$$= \ln(x \cdot x) = \ln(x) + \ln(x)$$

$$\lim_{x \rightarrow 1} \frac{\cos\left(\frac{\pi}{2}x\right)}{x-1} = \lim_{x \rightarrow 1} \frac{-\frac{\pi}{2} \sin\left(\frac{\pi}{2}x\right)}{1} = -\frac{\pi}{2}$$

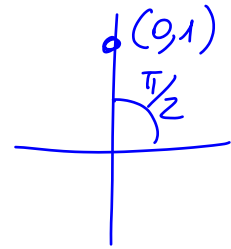

$$h(x) = \cos\left(\frac{\pi}{2}x\right) = f(g(x))$$

$$y = g(x) = \frac{\pi}{2}x \quad f(y) = \cos(y)$$

$$h'(x) = f'(y) \cdot g'(x) = -\sin(y) \cdot \frac{\pi}{2} = -\frac{\pi}{2} \sin\left(\frac{\pi}{2}x\right)$$

$$\cos(\pi - \alpha) = -\cos(\alpha)$$

$$\sin(\pi - \alpha) = \sin(\alpha)$$

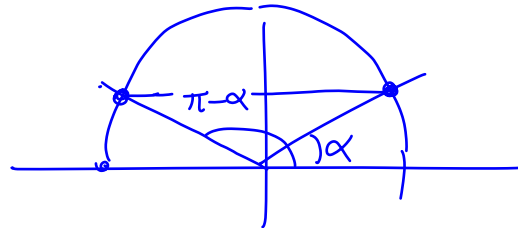

$$\lim_{x \rightarrow 0} \frac{\sin(\pi - x^2)}{7x^2 e^x} =$$

$$= \lim_{x \rightarrow 0} \frac{\sin(x^2)}{7x^2 e^x} = \frac{1}{7}$$

$$\lim_{x \rightarrow 0} \frac{\sin(\pi - x^2)}{7x^2 e^x} = \lim_{x \rightarrow 0} \frac{\cos(\pi - x^2) \cdot (-2x)}{7 \cdot (2x \cdot e^x + e^x \cdot x^2)} =$$

$$= \lim_{x \rightarrow 0} \frac{-2x \cdot \cos(\pi - x^2)}{7 \cancel{x} e^x (2 + x)} = \frac{-\cancel{2} \cdot \cos(\pi)}{7 \cdot 1 \cdot \cancel{2}} = \frac{1}{7}$$

$$\lim_{x \rightarrow \infty} \frac{2x^3 + x^2 - 1}{5x^3 - x + 3} = \frac{2}{5} = \lim_{x \rightarrow \infty} \frac{2 \cdot 3x^2 + 2x}{5 \cdot 3x^2 - 1} = \frac{\infty}{\infty}$$

$$= \lim_{x \rightarrow \infty} \frac{6 \cdot 2x + 2}{15 \cdot 2x} =$$

$$f(x) = x^n \quad f'(x) = n x^{n-1}$$

$$= \lim_{x \rightarrow \infty} \frac{\cancel{12}^2}{\cancel{30}_5} = \frac{2}{5}$$

$$f(x) + g(x) \quad | \quad f'(x) + g'(x)$$

$$k f(x)$$

$$k f'(x) \quad k = \text{cost.}$$

$$f(x)g(x)$$

$$f'(x)g(x) + f(x)g'(x)$$

$$\frac{f(x)}{g(x)}$$

$$\frac{f'(x)g(x) - f(x)g'(x)}{g^2(x)}$$

$$f(g(x))$$

$$f'(y) \cdot g'(x) \quad \text{dove } y = g(x)$$

$$y = f^{-1}(x)$$

$$\frac{1}{f'(y)} \quad \text{dove } y = f^{-1}(x)$$

$$x = f(y)$$

$$\frac{1}{f'(x)}$$

$$- \frac{f'(x)}{f^2(x)}$$

$$f(x) = a^x \quad f'(x) =$$

$(a > 0)$

$$x^n$$
$$n x^{n-1}$$

$$g(x) = x^a$$

$$g'(x) = a x^{a-1}$$

$$a = e^{\ln(a)}$$

$$h(x) = e^x \quad h'(x) = e^x$$

$$a^x = \left(e^{\ln(a)} \right)^x = e^{x \cdot \ln(a)}$$

$$e^{\ln(u)} = u$$

$$\ln(e^u) = u$$

$$(A^b)^c = A^{bc}$$

$$\& f(x) = e^x \quad f^{-1}(x) = \ln(x)$$

$$f(f^{-1}(x)) = e^{\ln(x)} = x$$

$$f^{-1}(f(x)) = \ln(e^x) = x$$

$$f(x) = a^x = e^{x \cdot \ln(a)} = e^y \quad y = x \cdot \ln(a)$$

$$f'(x) = e^y \cdot \ln(a) = e^{x \ln(a)} \cdot \ln(a) = \ln(a) a^x$$

$$f(x) = 2^x \quad f'(x) = \ln(2) \cdot 2^x$$

$$h(x) = \ln|x| = \begin{cases} \ln(x) & x > 0 \\ \ln(-x) & x < 0 \end{cases}$$

$$h'(x) = \begin{cases} \frac{1}{x} & x > 0 \\ \frac{1}{x} & x < 0 \end{cases}$$

$$\ln(y) \quad y = -x$$

$$h'(x) = \frac{1}{x}$$

$$\frac{1}{y} \cdot (-1) = \frac{1}{x}$$

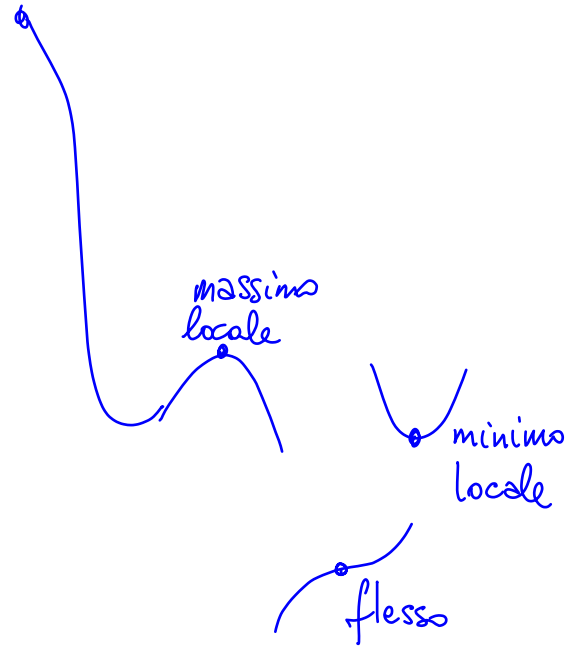
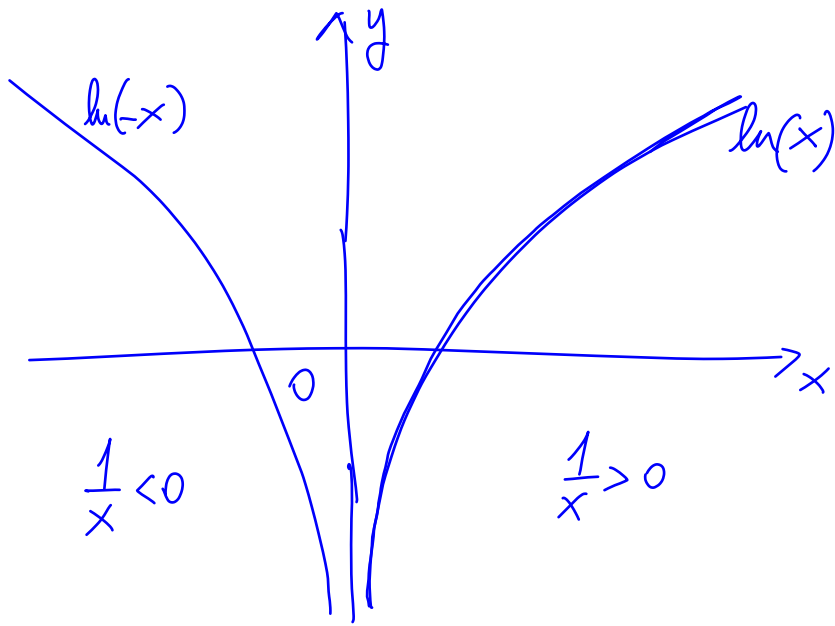

Studio di funzioni $y = f(x)$

$f(x)$ cresce dove $f'(x) > 0$

$f(x)$ decresce dove $f'(x) < 0$

$f(x)$ è stazionaria dove $f'(x) = 0$

Punti stazionari : x tale che $f'(x) = 0$

Sono massimi locali se $f''(x) < 0$

Sono minimi locali se $f''(x) > 0$

se $f''(x) = 0$ chissà!

$$y = f(x) = x \cdot e^x$$

dominio : \mathbb{R}

e^x è sempre > 0

$f(x) > 0$ per $x > 0$

$f(x) < 0$ per $x < 0$

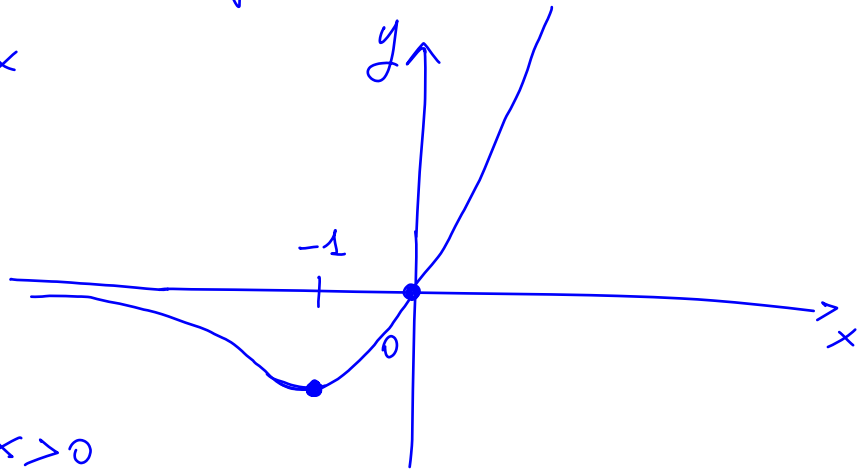

$$\lim_{x \rightarrow +\infty} f(x) = +\infty$$

$$\lim_{x \rightarrow -\infty} f(x) = 0$$

$$\lim_{x \rightarrow -\infty} x e^x = \lim_{x \rightarrow -\infty} \frac{x}{e^{-x}}$$

$$a = \frac{1}{a^{-1}}$$

$$a = e^x$$

$$y = -x$$

$$a^{-1} = (e^x)^{-1} = e^{-x}$$

$$= \lim_{y \rightarrow +\infty} \frac{y}{e^y} \stackrel{\text{Hopital}}{=} \lim_{y \rightarrow +\infty} \frac{1}{e^y} = 0$$

$$f'(x) = 1 \cdot e^x + e^x \cdot x = (1+x)e^x$$

$$f(x) = x \cdot e^x$$

$$f'(x) = 0 \quad \text{per } x = -1$$

$$f(-1) = -e^{-1} \approx -\frac{1}{2.718}$$

$$f'(x) > 0 \quad \text{per } x > -1$$

$$f'(x) < 0 \quad \text{per } x < -1$$

$$f''(x) = 1 \cdot e^x + e^x \cdot (1+x) = e^x \cdot (2+x)$$

$$f''(-1) = e^{-1} (2-1) = \frac{1}{e} > 0$$

Studiare $y = f(x) = \frac{1}{1+x^2}$ dominio: \mathbb{R}

Sempre positiva $\lim_{x \rightarrow \pm\infty} f(x) = 0$

$$f(x) = f(-x)$$

$$f'(x) = -\frac{2x}{(1+x^2)^2}$$

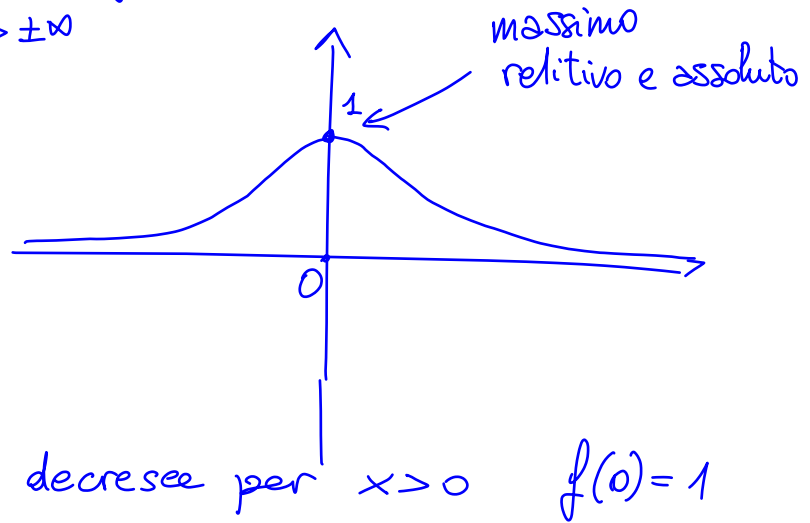

Punti stazionari: $x=0$

$f(x)$ cresce per $x < 0$, decresce per $x > 0$ $f(0) = 1$

$$f(x) = e^{-x^2}$$

$$\lim_{x \rightarrow \pm\infty} e^{-x^2} = \lim_{x \rightarrow \pm\infty} \frac{1}{e^{x^2}} = 0$$

dominio: \mathbb{R} sempre positiva

$f(x) = f(-x)$: è una funzione pari

$$\text{"} e^{-\infty} = 0 \text{"}$$

$$\text{"} e^{+\infty} = +\infty \text{"}$$

$$\begin{aligned} f'(x) &= e^y \cdot (-2x) \\ &= -2x e^{-x^2} \end{aligned}$$

$$\begin{aligned} f(x) &= e^{-x^2} = e^y \\ & \quad y = -x^2 \end{aligned}$$

Punti stazionari: $x=0$

$f(x)$ cresce per $x < 0$
decrece per $x > 0$

$$f(0) = 1$$

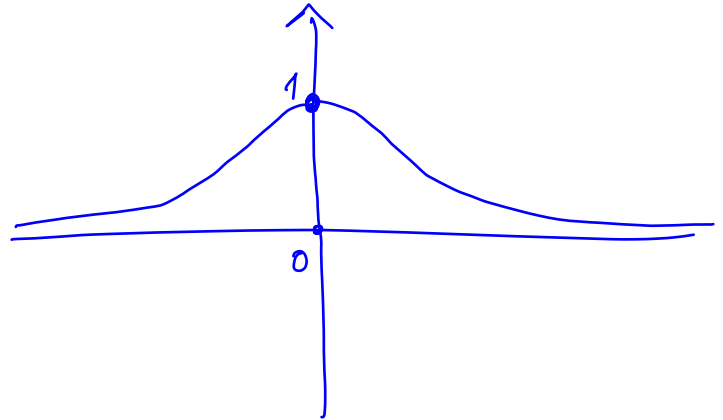

Se $f(x)$ ha derivata $f'(x)$ si dice
che $f(x)$ è una primitiva di $f'(x)$.

Data $g(x)$ si dice primitiva di $g(x)$
una qualunque funzione $G(x)$ tale che
 $G'(x) = g(x)$

Es.: a ha come primitiva $ax + C$ $a = \text{costante}$
 ax ha come primitiva $\frac{ax^2}{2} + C$ $C = \text{costante}$

$\frac{x^2}{2}$ ha derivata $\frac{2x}{2}$

e^x	há	come	primitiva	$e^x + C$
$\frac{1}{x}$	"	"	"	$\ln x + C$
$\cos(x)$	"	"	"	$\sin(x) + C$
$\sin(x)$	"	"	"	$-\cos(x) + C$
$\ln(x)$...			
x^n	"	"	"	$\frac{x^{n+1}}{n+1} + C$

$$f(x) = x^{n+1}$$

$$f'(x) = (n+1)x^n$$

$$f(x) = \frac{x^{n+1}}{n+1}$$

$$f'(x) = x^n$$

Significato della primitiva

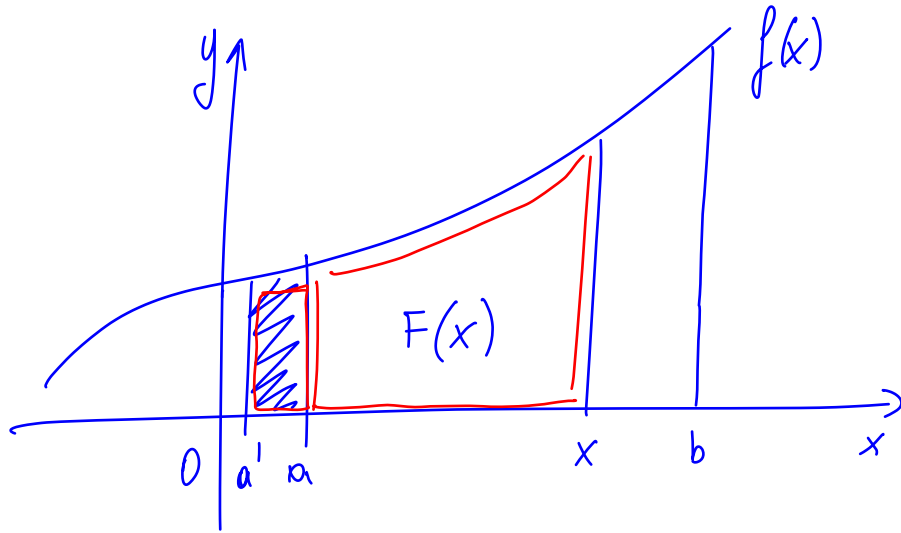

Sia $f(x)$ continua in $[a, b]$ e $x \in [a, b]$
Sia $F(x)$ una
primitiva di $f(x) =$

area

sottesa dal grafico
di $f(x)$ tra a e x

$a =$ costante

$$F'(x) = \lim_{\delta \rightarrow 0} \frac{F(x+\delta) - F(x)}{\delta} = f(x)$$

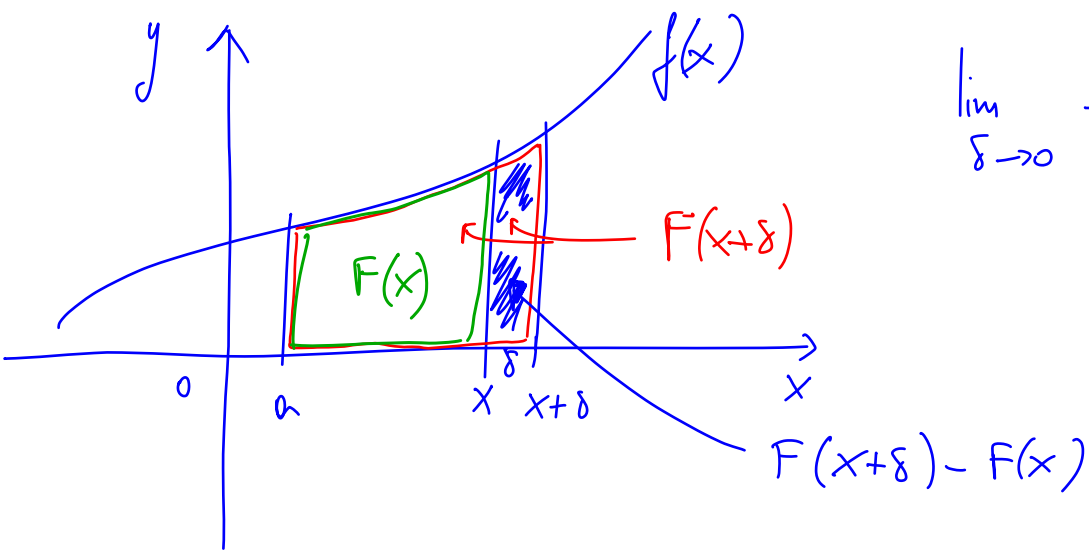

$$\lim_{\delta \rightarrow 0} \frac{F(x+\delta) - F(x)}{\delta}$$

$$f(x)\delta \leq F(x+\delta) - F(x) \leq \delta f(x+\delta)$$

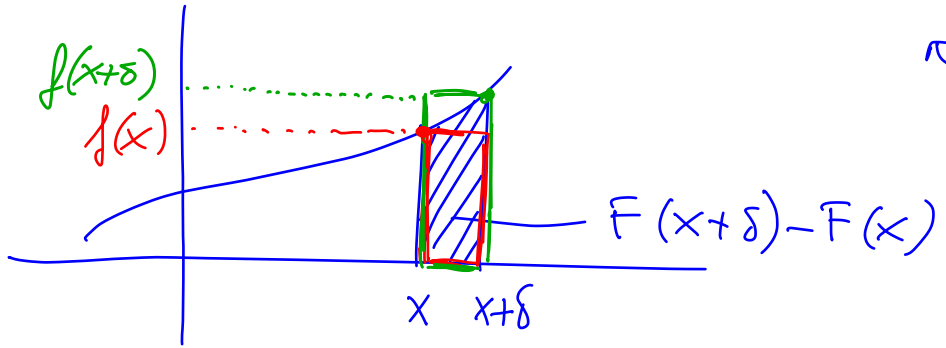

↳ divide tutto per δ

$$f(x) \leq \frac{F(x+\delta) - F(x)}{\delta} \leq f(x+\delta) \quad \delta \rightarrow 0$$

↑
 tende a $f(x)$
 per $\delta \rightarrow 0$
 (non dipende da δ)

↑
 $F'(x)$

↑
 tende a $f(x)$
 (perché f è continua)

Teorema del confronto $\Rightarrow F'(x) = f(x)$

$$F(x) = \int_a^x f(t) dt$$

integrale di $\underbrace{f dt}_{f(t)}$

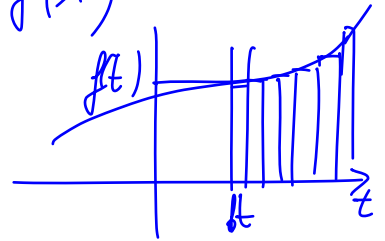

}
 "Somma"

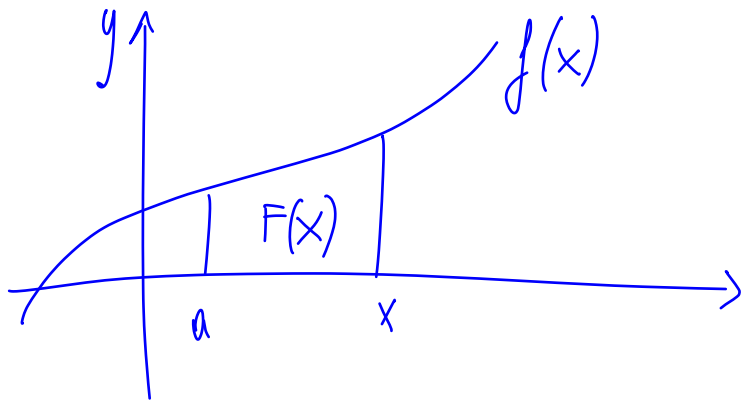

La primitiva di $f(x) + g(x)$ è $F(x) + G(x)$
 dove F e G sono, rispettivamente, le primitive di
 f e g

La primitiva di $k f(x)$ è $k F(x)$, $k = \text{costante}$

La primitiva di $f(x)g(x) = ?$

È forse $F(x)G(x)$?

No, perché la derivata di $F \cdot G$ è

$$\begin{aligned} F'(x)G(x) + F(x)G'(x) &= \\ = f(x)G(x) + F(x)g(x) \end{aligned}$$

Però sappiamo che la derivata di $F(x)g(x)$ è

$$f(x)g(x) + F(x)g'(x)$$

Quindi, la primitiva di $f(x)g(x) + F(x)g'(x)$ è $F(x)g(x)$

$$\text{prim}(f(x)g(x) + F(x)g'(x)) = F(x)g(x)$$

$$\text{prim} (f(x) g(x)) = F(x) g(x) - \text{prim} (F(x) g'(x))$$

(formula per l'integrale per parti)

$\ln|x|$: trovare una primitiva

$$1. \ln|x| = f(x) \cdot g(x)$$

$$f(x) = 1 \quad g(x) = \ln|x|$$

$$F(x) = x$$

$$g'(x) = \frac{1}{x}$$

$$\text{prim} (\ln|x|) = x \ln|x| - \text{prim} (1) = \underline{x \ln|x| - x} + C$$

$$\begin{aligned} \text{derivata di } x \ln|x| - x &= 1 \cdot \ln|x| + \cancel{x \cdot \frac{1}{x}} - 1 \\ &= \ln|x| \end{aligned}$$

derivata della funzione composta :

$$h(x) = f(g(x)) \quad y = g(x)$$

$$h'(x) = f'(y) \cdot g'(x) \quad \text{dove } y = g(x)$$

Quindi so fare la primitiva di

$$g'(x) f'(g(x)) \quad \text{--->} \quad \text{che è } f(g(x))$$

$$\cos(x) \xrightarrow{\text{primitiva}} \sin(x)$$

$$\begin{array}{l} 2x \cos(x^2) = g'(x) \cos(g(x)) \xrightarrow{\text{prim}} \sin(g(x)) \\ g'(x) \quad g(x) = y \quad \sin(x^2) \end{array}$$

Verifica: derivata di $\sin(x^2)$ $y = g(x) = x^2$

$$h(x) = f(g(x))$$

$$f(y) = \sin(y)$$

$$h'(x) = f'(y) \cdot g'(x) = \cos(x^2) \cdot 2x$$

$$x^n \rightarrow nx^{n-1}$$

$$n=-1 \quad \frac{1}{x} \rightarrow -\frac{1}{x^2}$$

$$\lim_{x \rightarrow 0} x \cdot \ln|x| = \lim_{x \rightarrow 0} \frac{\ln|x|}{\frac{1}{x}} = \frac{0 \cdot (-\infty)}{\pm \infty}$$

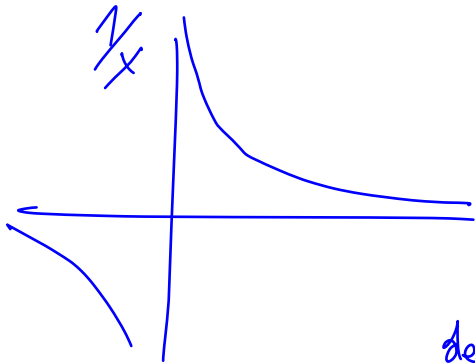

$$= \lim_{x \rightarrow 0} \frac{\frac{1}{x} \cdot x^2}{-\frac{1}{x^2} \cdot x^2} = \lim_{x \rightarrow 0} (-x) = 0$$

de l'Hopital

$$\lim_{x \rightarrow 0} x \ln|x| = 0$$

Studiare $x e^x$ $\frac{x}{1+x^2}$ $x^3 e^{-x^2}$

Trovare la primitiva di $\frac{3x^2}{3} e^{x^3} = \frac{1}{3} e^{x^3}$

e^y $y = x^3$ $y' = 3x^2$

Verifica: derivata di $\frac{e^{x^3}}{3} = \frac{\cancel{3}x^2 \cdot e^{x^3}}{\cancel{3}} = x^2 e^{x^3}$

Esercizi di riepilogo

$$2x + 5y = -1$$

$$-x - 3y = 2$$

Se $X = \begin{pmatrix} x \\ y \end{pmatrix}$ trovare la matrice A e il vettore V

tale che $AX = V$

Calcolare A^{-1} , $\det A$ e la soluzione $X = A^{-1}V$

Sia $B = \begin{pmatrix} 6 & 2 \\ 2 & 1 \end{pmatrix}$ calcolare $\det B$, B^{-1} e B^2

Calcolare $h'(x)$ se $h(x) = \ln |\cos(x)|$

$h'(x)$ se $h(x) = x \cdot \sin(e^x)$

$$h'(x) \text{ se } h(x) = x \cos(x+1)$$

$$\lim_{x \rightarrow \infty} x^3 \cdot e^{-x^2} = 0$$

$$\infty \cdot e^{-\infty}$$

potencia

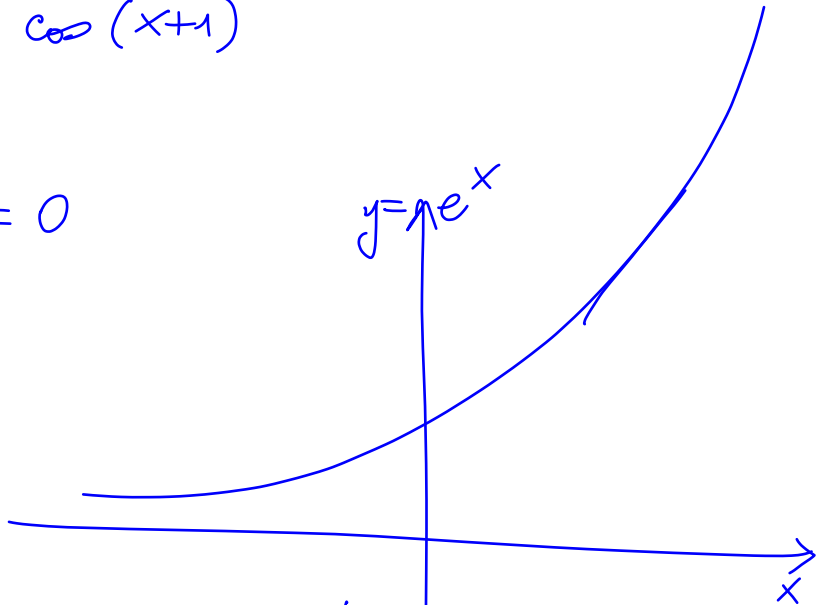

$$\lim_{x \rightarrow \infty} \frac{x^3}{e^{x^2}} = \lim_{x \rightarrow \infty} \frac{3x^2}{e^{x^2} \cdot 2x} = \frac{3}{2} \lim_{x \rightarrow \infty} \frac{x}{e^{x^2}} =$$

$$= \frac{3}{2} \lim_{x \rightarrow \infty} \frac{1}{e^{x^2} \cdot 2x} = 0$$

Hopital

Hopital 2

$$\frac{1}{a} = a^{-1} \quad \frac{1}{a^b} = a^{-b} \quad \frac{1}{e^u} = e^{-u}$$

Studiare la funzione $f(x) = xe^x$

Dominio: \mathbb{R}

positiva in: $(0, \infty)$

negativa in: $(-\infty, 0)$

$\lim_{x \rightarrow \infty} f(x) = +\infty$

$\lim_{x \rightarrow -\infty} f(x) = 0$

derivata = $(x+1)e^x = f'(x)$

crece in: $f'(x) > 0$ per $x+1 > 0$, $x > -1$

decresce in: $x < -1$

stationaria in: $x = -1$

$$f(-1) = -1 \cdot e^{-1} = -\frac{1}{e}$$
$$e = 2.781... \quad f(-1) \sim -0.37$$

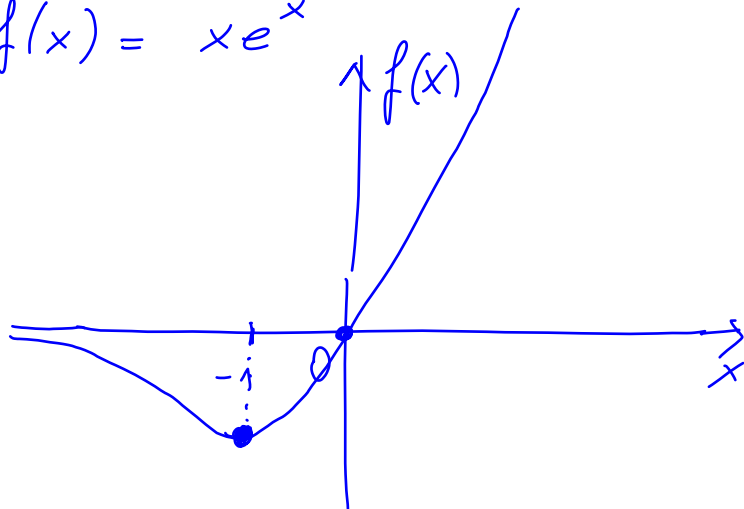

$$f(0) = 0$$

Studiare la funzione $f(x) = \frac{x}{1+x^2}$

Dominio: \mathbb{R}

$$x \rightarrow \infty: \frac{\infty}{\infty} \text{ Hopital } \frac{1}{2x} \rightarrow 0$$

positiva in: $(0, \infty)$

negativa in: $(-\infty, 0)$

$$\lim_{x \rightarrow +\infty} f(x) = 0$$

$$\lim_{x \rightarrow -\infty} f(x) = 0$$

$$\text{derivata} = f'(x) = \frac{1-x^2}{(1+x^2)^2}$$

crece in: $(-1, 1)$ $f'(x) > 0$

decresce in: $(-\infty, -1) \cup (1, \infty)$

stazionaria in: $f'(x) = 0$ in $x^2 = 1$ $x = \pm 1$

$$f(0) = 0 \quad f(1) = \frac{1}{2} \quad f(-1) = -\frac{1}{2}$$

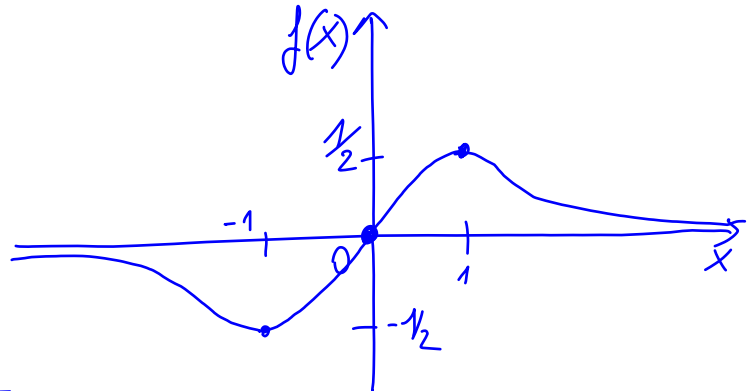

$$f(-x) = -f(x)$$

$$f(x) = x e^{-x^2}$$

Dominio: \mathbb{R}

positiva in: $(0, \infty)$

negativa in: $(-\infty, 0)$

$$\lim_{x \rightarrow +\infty} f(x) = 0$$

$$\lim_{x \rightarrow -\infty} f(x) = 0$$

$$\text{derivata} = f'(x) = e^{-x^2} (1 - 2x^2)$$

crece in: $(-\frac{1}{\sqrt{2}}, \frac{1}{\sqrt{2}})$

decresce in: $(-\infty, -\frac{1}{\sqrt{2}}) \cup (\frac{1}{\sqrt{2}}, \infty)$

stationaria in: $x = \pm \frac{1}{\sqrt{2}}$

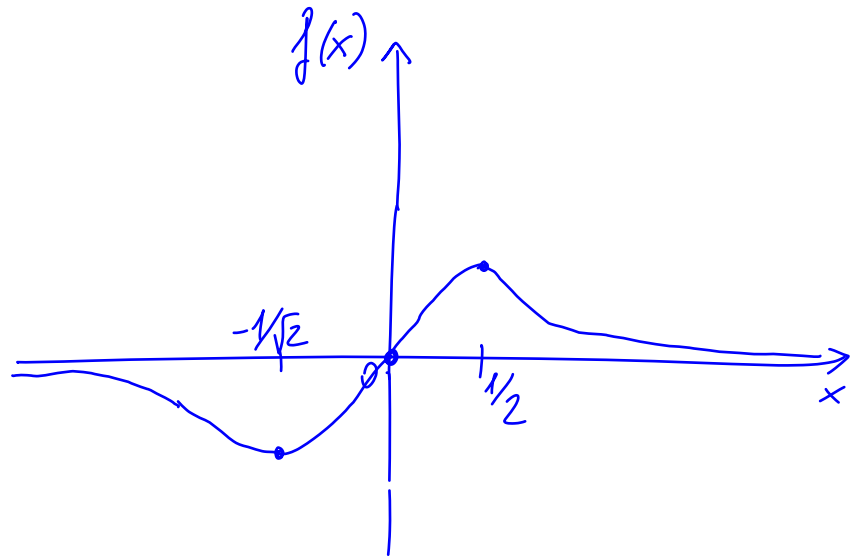

Derivata di $\ln^2 |x| = f(x) = (\ln|x|)^2$

$$f'(x) = 2y \cdot \frac{1}{x} = \frac{2 \ln|x|}{x} \quad y^2 \quad y = \ln|x|$$

$$f(x) = \ln|x| \cdot \ln|x|$$

$$f'(x) = \frac{1}{x} \cdot \ln|x| + \ln|x| \cdot \frac{1}{x} = \frac{2 \ln|x|}{x}$$

$$f(x) = x^n \quad f'(x) = n x^{n-1}$$

$$h(x) = (g(x))^n = f(g(x)) \quad h'(x) = f'(y) \cdot g'(x)$$
$$y = g(x) \quad f(y) = y^n \quad = n(g(x))^{n-1} g'(x)$$

$$f(x) = \frac{\sin(x)}{x}$$

$$f'(x) = \frac{x \cos(x) - \sin(x)}{x^2}$$

Primitiva di $\frac{1}{x} = \ln|x|$

" " $\frac{1}{x+1} = \ln|x+1|$

" " $\frac{2x}{1+x^2} = \ln(1+x^2)$

$$f(x) = \ln(1+x^2) \quad f'(x) = \frac{1}{1+x^2} \cdot 2x$$

Primitiva di $2x e^{x^2} = e^{x^2}$

$$f(x) = e^{x^2} \Rightarrow f'(x) = e^{x^2} \cdot 2x$$

$(2x+1) e^{\overbrace{x^2+x}}$ primitiva = e^{x^2+x}

$$x^4 \text{ deriv} = 4x^3$$

Primitiva di $7x^3$ $\frac{7x^4}{4}$

" " $5x^6$: $\frac{5x^7}{7}$

" " $f'(x) \cdot f(x)$ $e^{-\frac{1}{2} (f(x))^2}$

derivata di $\frac{1}{2} (f(x))^2 = \frac{1}{2} 2 f(x) \cdot f'(x)$

$$f(x) = \frac{x}{x-1}$$

Dominio: $\mathbb{R} \setminus \{1\}$

positiva in: $x > 0, x > 1$ o $x < 0, x < 1$ cioè $(-\infty, 0) \cup (1, \infty)$

negativa in: $(0, 1)$

$$\lim_{x \rightarrow +\infty} f(x) = 1 \quad \lim_{x \rightarrow 1^+} f(x) = \infty$$

$$\lim_{x \rightarrow -\infty} f(x) = 1 \quad \lim_{x \rightarrow 1^-} f(x) = -\infty$$

$$\text{derivata} = \frac{1 \cdot (x-1) - 1 \cdot x}{(x-1)^2} = \frac{-1}{(x-1)^2}$$

cresea in: mai

decresea in: sempre

stationaria in: non ci sono

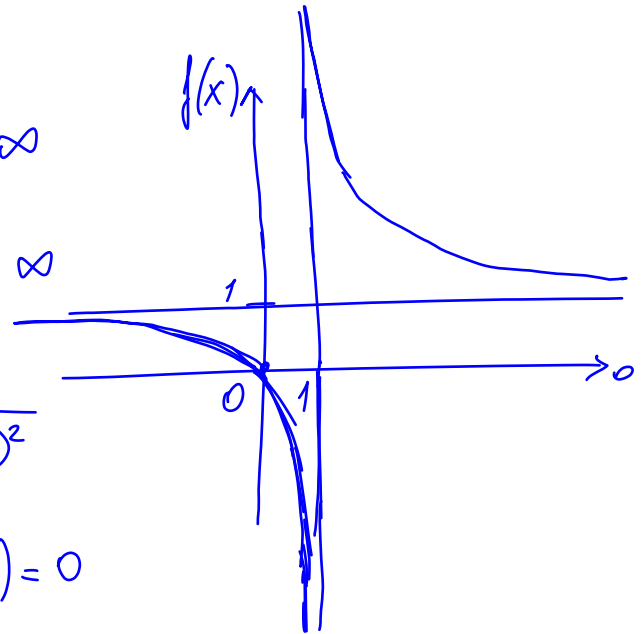

$$f(0) = 0$$

$$\text{Primitiva di } \frac{1}{x} \ln|x| = f'(x) f(x)$$

$$| \quad \quad \quad f(x) = \ln|x|$$

$$= \frac{1}{2} (f(x))^2 = \frac{1}{2} \ln^2|x|$$

$$\text{Primitiva di } e^x \sin(e^x) \dots e^{-x} - \cos(e^x)$$

$$f(x) = e^x \quad f'(x) \sin(f(x))$$

$$\text{Primitiva di } \frac{1}{2} 2e^x \sin(2e^x) \dots e^{-x} - \frac{1}{2} \cos(2e^x)$$

$$f'(x) = 2e^x \quad f(x) = 2e^x \quad \frac{1}{2} f'(x) \sin(f(x))$$

Calcolare l'area di

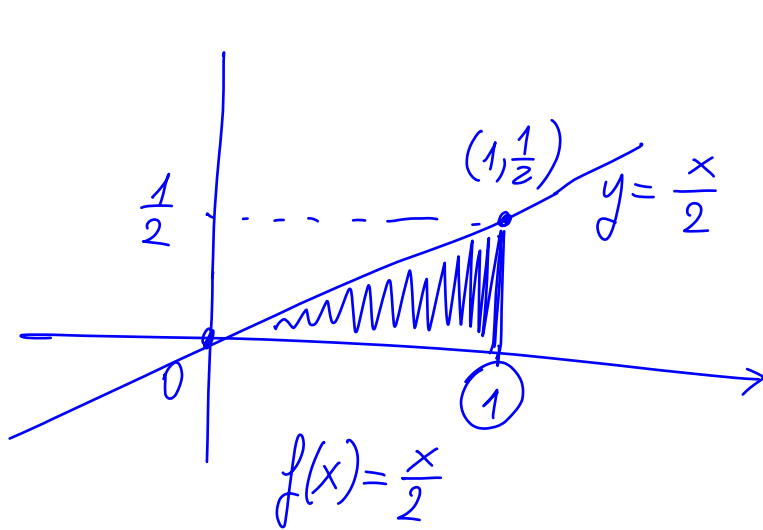

$$\frac{1}{4}$$

$$y = mx + q$$

$$\underline{q=0}$$

$$y = mx$$

passa per $(1, \frac{1}{2})$

$$\frac{1}{2} = m \cdot 1 \Rightarrow m = \frac{1}{2}$$

Primitiva di $\frac{x}{2}$ è $F(x) = \frac{x^2}{4} + C$

Verifica dell'area $F(1) - F(0) = \frac{1}{4} + C - C = \frac{1}{4}$

$$F'(x) = f(x)$$

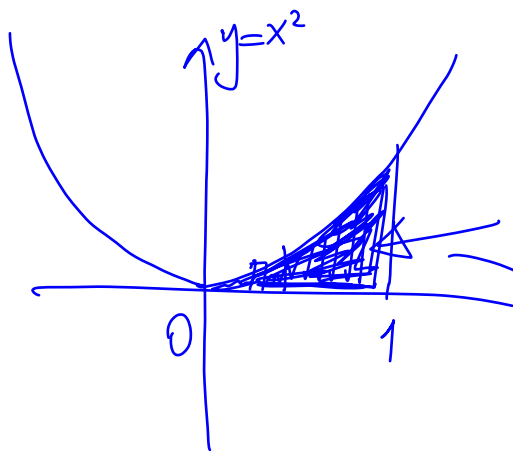

$$f(x) = x^2$$

$$F(x) = \frac{1}{3} x^3 + C$$

calcolare

$$\text{Area} = F(1) - F(0) =$$

$$= \frac{1}{3} + \cancel{C} - \cancel{C} = \frac{1}{3}$$

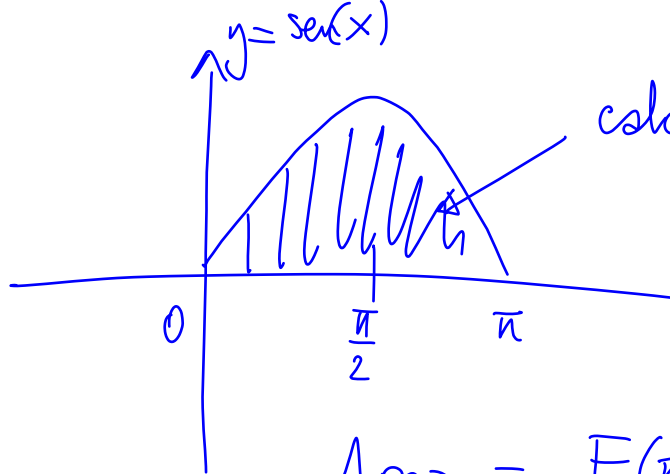

calcolare

$$f(x) = \sin(x)$$

$$F(x) = -\cos(x) + C$$

$$\text{Area} = F(\pi) - F(0) = 1 + \cancel{C} - (-1 + \cancel{C}) = 2$$

Studiare $f(x) = \sin(x^2)$ per $x \in [0, \sqrt{\pi}]$

$$f(0) = 0$$

$$f(\sqrt{\pi}) = 0$$

$$\text{derivata: } 2x \cdot \cos(x^2)$$

$$\text{punti stazionari: } x=0, x=\sqrt{\frac{\pi}{2}}$$

$$\text{cresce per: } x \in [0, \sqrt{\frac{\pi}{2}}]$$

$$\text{decresce per: } x \in [\sqrt{\frac{\pi}{2}}, \sqrt{\pi}]$$

$$f\left(\sqrt{\frac{\pi}{2}}\right) = \sin\left(\frac{\pi}{2}\right) = 1$$

$$y = x^2 = g(x) \quad f(y) = \sin(y)$$

$$h(x) = f(g(x)) = \sin(x^2)$$

$$h'(x) = f'(y) \cdot g'(x)$$

$$\text{dove } y = g(x)$$

$$f'(y) = \cos(y)$$

$$g'(x) = 2x$$

$$\cos(y) = 0 \text{ per}$$

$$x^2 = y = \frac{\pi}{2}, \frac{3\pi}{2}, \dots + 2\pi k$$

$$\frac{\pi}{2}, \frac{3\pi}{2}, \frac{5\pi}{2}, \dots \quad k=1,2,3, \dots$$

$-1, -2, \dots$

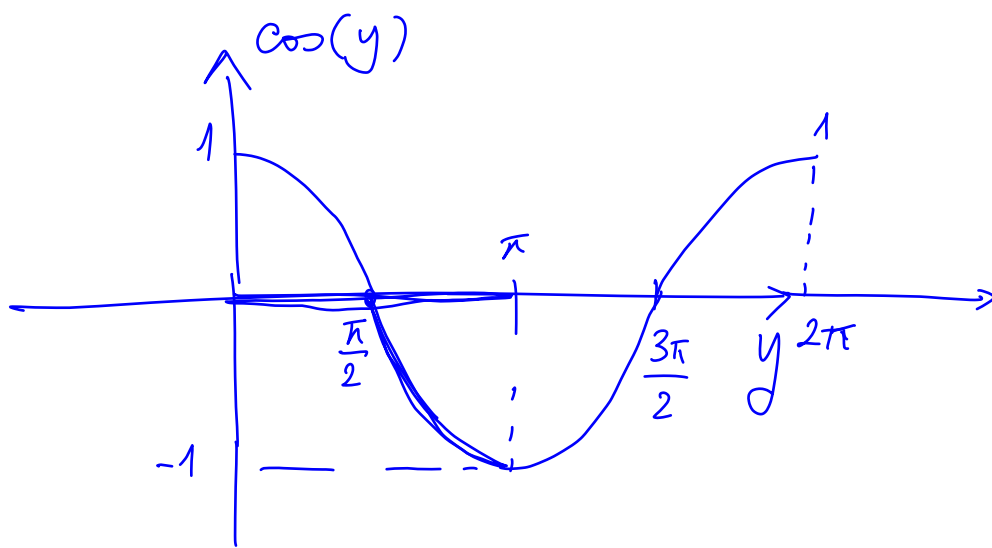

$$\cos(y) > 0$$

Se $x \in [0, \sqrt{\pi}]$ $x = \sqrt{y}$

$$y = x^2 \in [0, \pi]$$

$\cos(y) > 0$ per $y \in [0, \frac{\pi}{2}]$ cioè $x \in [0, \sqrt{\frac{\pi}{2}}]$

$\cos(y) < 0$ per $y \in [\frac{\pi}{2}, \pi]$ cioè $x \in [\sqrt{\frac{\pi}{2}}, \sqrt{\pi}]$

grafico:

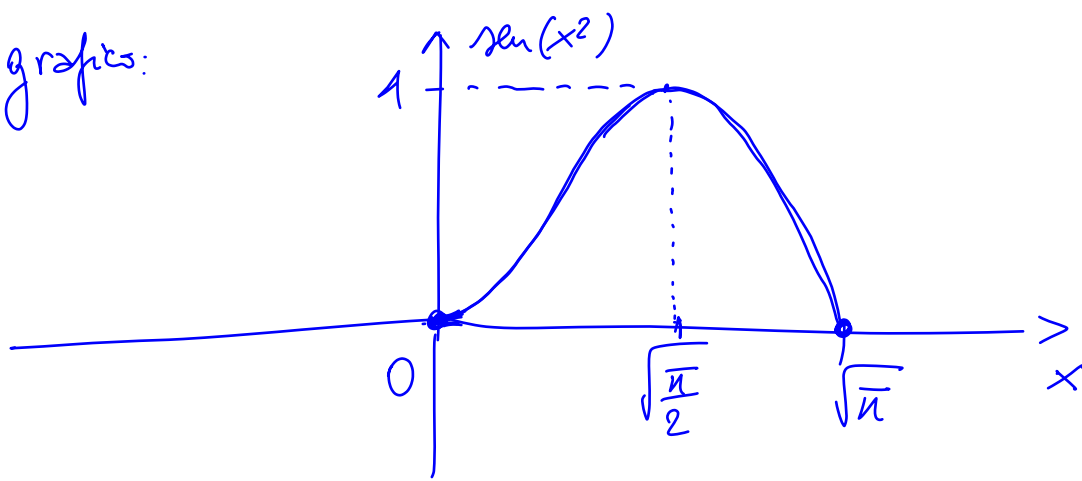

Studiare $f(x) = x^2 e^{-x^2}$

$$f(-x) = f(x)$$

funzione
pari

dominio: \mathbb{R}

$$\lim_{x \rightarrow +\infty} f(x) = \lim_{x \rightarrow \infty} \frac{x^2}{e^{x^2}} \stackrel{\infty/\infty}{=} \lim_{x \rightarrow \infty} \frac{\cancel{2x}}{\cancel{2x} e^{x^2}} =$$

$$= \lim_{x \rightarrow \infty} \frac{1}{e^{x^2}} = \frac{1}{\infty} = 0$$

$$\lim_{x \rightarrow -\infty} f(x) = 0 \quad f(x) = x^2 e^{-x^2}$$

$$f'(x) = 2x \cdot e^{-x^2} + x^2 \operatorname{deriv}(e^{-x^2})$$

$$\operatorname{deriv.}(e^{-x^2}) = -2x e^{-x^2} \quad a^2 - b^2 = (a-b)(a+b)$$

$$\begin{aligned} f'(x) &= 2x e^{-x^2} + x^2 \cdot (-2x) \cdot e^{-x^2} = \\ &= 2x \cdot e^{-x^2} \cdot (1 - x^2) \end{aligned}$$

punti stazionari: $f'(x) = 0$ per $x = 0, \pm 1$

cresce dove $x(1-x^2) > 0$

$$x(1-x)(1+x) > 0$$

$$x \cdot (1-x) \cdot (1+x) > 0$$

+ + +

$$x > 0, 1-x > 0, 1+x > 0$$

$$x > 0, x < 1, \cancel{x > -1}$$

$$\underline{0 < x < 1}$$

- - +

$$x < 0, 1-x < 0, 1+x > 0$$

$$x < 0, x > 1 : \text{impossibile}$$

+ - -

$$x > 0, 1-x < 0, 1+x < 0$$

$$x > 0, x < 1, x < -1 \text{ impossibile}$$

- + -

$$x < 0, 1-x > 0, 1+x < 0$$

$$x < 0 \quad 1-x > 0 \quad 1+x < 0$$

$$\cancel{x < 0} \quad \cancel{x < 1} \quad x < -1 \quad \text{OK per } \underline{\underline{x < -1}}$$

$f(x)$ cresce per $x < -1$ e $0 < x < 1$

$$f(1) = e^{-1} = \frac{1}{e} = \frac{1}{2.7...} \sim 0.4 \quad f(x) = x^2 e^{-x^2}$$

$$f(-1) = 0.4$$

$$f(0) = 0$$

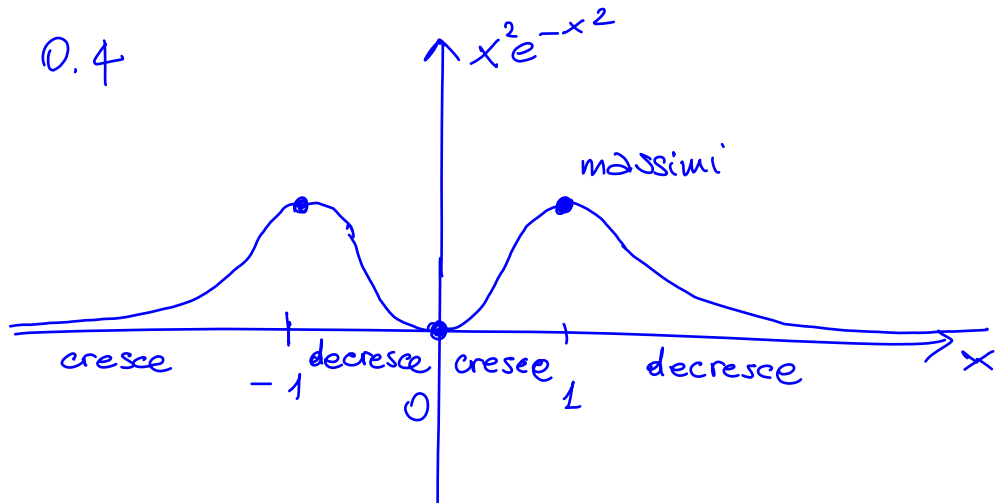

Studiare $f(x) = \frac{e^x}{x}$ dominio $\mathbb{R} \setminus \{0\}$

$$\lim_{x \rightarrow +\infty} \frac{e^x}{x} = \frac{\infty}{\infty} \text{ l'Hopital} \quad \lim_{x \rightarrow \infty} \frac{e^x}{1} = \infty$$

$$\lim_{x \rightarrow -\infty} \frac{e^x}{x} = 0 \quad \lim_{x \rightarrow 0^+} \frac{e^x}{x} = +\infty$$

$$\lim_{x \rightarrow 0^-} \frac{e^x}{x} = -\infty$$

$$\text{derivata: } \frac{e^x \cdot x - 1 \cdot e^x}{x^2} = \frac{x-1}{x^2} e^x$$

punti stazionari: $x=1$ cresce per $x > 1$ $f(1)=e$

